

ControlPlex[®] Rack **Plus voltage range (DC 24 V, 48 V, 60 V)** **Installation Instruction**



Date of issue:

Date of publication: November 2019

This document replaces the following documents:

»**ControlPlex® Rack**« I_19BGTCP_d_200617

Editor:

E-T-A Elektrotechnische Apparate GmbH

Industriestraße 2-8 · 90518 ALTDORF

GERMANY

Tel. 09187 10-0 · Fax 09187 10-397

E-Mail: info@e-t-a.de · www.e-t-a.de

Copyright® 2019 E-T-A GmbH

The contents of this document is the property of E-T-A GmbH. No part of this publication must in any way be reproduced or distributed without prior written consent of E-T-A GmbH. Any person acting illegally with regard to this publication can be prosecuted.

Limitation of liability

Although all provisions were taken when creating this document, the editor does not accept any responsibility for errors or omissions or for damages caused by using the information contained in this document. The information contained in this document may be revised at any time without pre-advise.

Brands

All references to software and hardware in this document are generally protected by brands or patents.

© E-T-A GmbH 2019. All rights reserved

About this manual

This manual describes the electrical start-up of the **ControlPlex® Rack** system in connection with compatible **ControlPlex® Rack** components. The **ControlPlex® Rack** allows artless and reliable protection and monitoring of plus-supplied systems.

Besides this document, more information about the E-T-A **ControlPlex® Rack** can be found in the following documents.

Latest changes and technical notes regarding the installation manual.

ControlPlex® Rack

Data sheet

Here you will find more technical data and figures as well as approval information on the various components of the **ControlPlex® Rack** system

ControlPlex® Rack

Operation instruction manual RCI10

Here you will find an instruction for configuration and for integrating the RCI10 Remote Control Interface module into your network. In addition this document holds a user description of the web browser and the SSH surface as well as the SNMP MIB for integration into a management system.

ControlPlex® Rack

Release Notes RCI10_SW_Vxx

Here you find the information of the extended performance features of the current software for the RCI10 sub-assembly.

ControlPlex® Rack

Application examples EAI300

Here you find further configuration and connection examples for the EAI300 module

The latest documents can be found on our website under:
www.e-t-a.de/controlplex_rack

All documents contain important instructions for connection and safe operation of the **ControlPlex® Rack** system. Safety instructions have to be observed. All users have to be informed about all safety instructions. The documents have to be accessible for the user.

Contents

About this manual	3
Contents	4
General information	6
1 Introduction	7
2 System design ControlPlex® Rack	8
2.1 Important information and safety instructions	8
2.2 EMC Installation Guidelines	9
2.3 Technical Accuracy	9
3 Power-D-Box® CP	10
3.1 Application Power-D-Box® CP (DC 24 V, 48 V, 60 V)	10
3.2 Technical data Power-D-Box® CP	10
3.3 Scope of delivery Power-D-Box® CP	11
3.4 Optional accessories Power-D-Box® CP	11
3.5 Pictures Power-D-Box® CP versions (front view)	11
3.6 Drawings and dimensions of Power-D-Box® CP versions	12
3.7 Schematic diagrams of Power-D-Box® CP versions	14
3.8 Pin selection Power-D-Box® CP versions	14
3.9 Installation and start-up of the Power-D-Box® CP	16
3.9.1 Recommended installation site for Power-D-Box® CP	16
3.9.2 Basic notes on cabling for Power-D-Box® CP	16
3.9.3 Mounting and start-up of Power-D-Box® CP	17
4 ESX300-S electronic circuit protector plus	19
4.1 Application ESX300-S <i>plus</i>	19
4.2 Technical data ESX300-S <i>plus</i>	19
4.2.1 Current rating, voltage drop and load capacity of ESX300-S <i>plus</i>	20
4.2.2 LED status indication	20
4.3 Scope of delivery ESX300-S <i>plus</i>	21
4.4 Picture ESX300-S <i>plus</i>	21
4.5 Installation and start-up ESX300-S <i>plus</i>	21
4.6 Configuration of the voltage range with ESX300-S <i>plus</i>	22
4.7 Disassembly of electronic circuit protector ESX300-S <i>Plus</i>	24
4.7.1 Disassembly of the electronic circuit protector ESX300-S <i>Plus</i> without extracting tool	24
4.7.2 Disassembly of electronic circuit protector ESX300-S <i>Plus</i> with extracting tool	25
4.8 Trouble-shooting concerning electronic circuit protector ESX300-S	26
5 Parallel connection of several ESX300-S plus	27
5.1 Parallel Application connection of several ESX300-S <i>plus</i>	27
5.2 Technical data load bridge for parallel connection of several ESX300-S <i>plus</i>	27
5.3 rating, voltage drop and load capacity of ESX300-S <i>plus</i>	28
5.4 Scope of delivery Parallel connection of several ESX300-S <i>plus</i>	28
5.5 Fig. Parallel connection of several ESX300-S <i>plus</i>	28
5.6 Installation and start-up of the parallel connection of several ESX300-S <i>plus</i>	29

6	RSI10 signal interface	30
6.1	Application RSI10	30
6.2	Technical data of RSI10	30
6.2.1	Operating conditions and LED indication	31
6.3	Delivery scope RSI10	32
6.4	Picture of RSI10	32
6.5	Installation and start-up RSI10	33
7	RCI10 control interface	34
7.1	Application RCI10	34
7.2	Technical data of RCI10	34
7.2.1	Momentary switch function and LED status indication	35
7.2.2	Function IP-reset by pressing the reset button with LED display	36
7.3	Delivery scope RCI10	36
7.4	Picture of RCI10	36
7.5	Installation and start-up RCI10	37
7.5.1	Picture of slot for RCI10 or RSI10	38
7.5.2	Picture of an example for network connection	38
7.6	Configuration and start-up RCI10	38
8	EAI300 E/A external alarm interface	39
8.1	Operating mode and application EAI300	39
8.2	Technical data of EAI300	39
8.2.1	Operating conditions LED signalling	40
8.3	Delivery scope EAI300	40
8.4	Picture EAI300	40
8.5	Installation and connection EAI300	41
8.5.1	Example: EAI300 slot configuration	42
8.5.2	EAI300 pin assignment and connection example	42
8.6	Configuration and start-up EAI300	42
9	Appendix	43
9.1	List of pictures	43

General Information

Qualified personnel

The system must only be installed, connected and configured in connection with this document. Installation and operation of the device/system must only be carried out by qualified personnel. With regard to the safety instructions of this documentation, qualified persons are persons authorised to operate devices, systems and circuits according to the standards and rules of safety engineering.



Safety instructions

Please follow the installation and configuration instructions given in this document carefully. Failure to comply may lead to serious damages of the product or the system. E-T-A does not accept any liability for problems caused by improper installation or handling by the customer or a third person.

Symbols

You will find the following symbols in the entire manual. Their meaning is as follows:



Danger!

You are in a situation which might cause injury. Before working with one of the devices you have to be aware of the risks of electrical circuitries and you ought to be familiar with standard procedures of accident prevention.



Warning

There is a risk in this situation to do something which might cause damage of the devices or data loss.



Note

Here you receive information which might be particularly useful for the application.



Caution

Electrostatically sensitive devices (ESD). Devices must exclusively be opened by the manufacturer.

1 Introduction

You chose **ControlPlex® Rack**, a comprehensive, future-oriented protection system which combines safety, user convenience and service friendliness. It is a power distribution and management system which provides electronic and, in the event of a short circuit, current-limiting protection of various loads. By means of an internal bus system and an additional control interface module (option), which can be plugged in on duty, each load can be remotely controlled and monitored. In addition it allows recording of measuring data of every single load. Besides providing overcurrent and short circuit protection, it increases system availability by a multiple, because it disconnects faulty loads quickly, selectively and without voltage dips.

The basic configuration consists of a **Power-D-Box® CP** and the ESX300-S electronic circuit protectors. Depending on the application requirements, the system can optionally be extended with the RCI10 Remote Control Interface for convenient remote access, the RSI10 Remote Signalling Interface for reliable potential-free signalling and the EAI300 External Alarm Interface for transparent integration of external sensors.

This document contains the mounting and connection procedures for the hardware of the **ControlPlex® Rack** system as well as an instruction for the first operation. You will learn more about

- how to mount and connect the different **Power-D-Box® CP** versions
- how to start up or exchange the electronic circuit protectors type ESX300-S
- how to identify and remedy failures of the electronic circuit protectors ESX300-S
- how to install and connect the optional control interface RCI10
- how to identify and remedy failures of the control interface RCI10 by means of LED indication
- how to install and connect the EAI300 external alarm interface.
- how to identify failures of the EAI300 by means of LED indication.

Further descriptions of the **ControlPlex® Rack** system with information on the configuration and network connection by means sub-assembly control interface RCI10 are available in the Operation instruction RCI10 manual **ControlPlex® Rack**.

2 System design *ControlPlex*[®] Rack

Please check the delivered components upon receipt with regard to completeness. You require the following hardware components for installation and start-up of the *ControlPlex*[®] Rack system:

- *Power-D-Box*[®] CP type: PDB-P-CP
- ESX300-S-310-xxA electronic circuit protectors with BUS interface; various current ratings: 2 A ... 24 A
- Optional: RCI10-000-x. control interface with Ethernet interface or RSI10-000-A signalling sub-assemblies
- Optional: EAI300 alarm interface for including additional »external« alarm contacts. Operation of EAI300 sub-assemblies requires control interface RCI10.

In addition you require different cables CP for connection of the *Power-D-Box*[®], of the supply line, the loads and the ground. Many manufacturers offer standard cables for this purpose.

2.1 Important information and safety instructions

The following table lists various information and safety instructions for start-up and use of the device.







	Danger: installation and operation of the device This device has to be installed and operated in compliance with the given instructions. Failure to comply can lead to injury, damage of loads or of the <i>ControlPlex</i> [®] Rack system.
	Danger: turn off the supply voltage Before beginning with installation, the system has to be disconnected from the mains. A cable connection must only be established if the supply voltage is OFF.
	Danger: possible ignition hazard The device must NOT be used in inflammable surroundings.
	Danger: high voltage The cover must NEVER be opened. Access to the inner components is not allowed unless indicated otherwise in this manual.
	Caution: work with ESD protection Electronic modules must only be touched and installed with ESD protection so as to ensure protection against electrostatic voltage. Failure to comply can cause damages on the <i>ControlPlex</i> [®] Rack system or the corresponding components.
	Warning: grounding The device must be grounded before switching on.

Table 1: Important information

2.2 EMC installation guidelines

The **ControlPlex® Rack** hardware and accessories comply with the EMC directives. Thus electromagnetic interferences between the devices are avoided which would otherwise affect the system performance. A professional installation is mandatory. In order to ensure the best EMC conditions, the widest possible distance between the different electrical devices should be applied.

2.3 Technical accuracy

All technical data in this manual were correct in all conscience at the time of printing. E-T-A cannot be held liable for any (inadvertent) errors. Due to continuous product improvements at E-T-A there could be discrepancies between the actual product and the manual. Product changes or amendments of the technical specifications will be carried out without prior notification. The latest versions of the **ControlPlex® Rack** documents are available on our website (www.e-t-a.de).

3 Power-D-Box[®] CP

3.1 Application Power-D-Box[®] CP (DC 24 V, 48 V, 60 V)

The **Power-D-Box[®] CP** has been designed for the quick and easy installation into 19" or ETSI racks which is ensured by a rotating mounting flange. Depending on the required termination technology (front or rear) the corresponding **Power-D-Box[®] CP** is available as a product. The service friendliness has to be

mentioned as a special advantage. The system can be extended with power on and additional circuit protectors can be plugged into the load terminals. The control interface can also be fitted later with power on without having to disconnect the loads.

3.2 Technical data Power-D-Box[®] CP

Electrical data	PDB-P-CP09A-RR-A2	PDB-P-CP09A-RF-A2	PDB-P-CP09A-FF-A2	PDB-P-CP19A-RR-A2	PDB-P-CP18R-RR-A2
Operating voltage	DC 24 V, DC 48 V, DC 60 V	DC 24 V, DC 48 V, DC 60 V	DC 24 V, DC 48 V, DC 60 V	DC 24 V, DC 48 V, DC 60 V	DC 24 V, DC 48 V, DC 60 V
Max. supply current	150 A	150 A	100 A	200 A	2 x 150 A
Number of circuit protectors	9	9	9	19	18
Redundant system	No	No	No	No	Yes
Protected pole	Positive pole protected electronically, without physical isolation				
Suitable for circuit protectors	ESX300-S-31x (2 A, 5 A, 8 A, 12 A, 16 A, 20 A, 24 A, with BUS)				
Ambient temperature	-20 ... +60 °C				
Mechanical data					
Dimensions	see drawings and dimensions				
Mounting method	4 mounting screws M6 x 16 mm (not supplied with product) tightening torque 5.3 ... 5.7 Nm				
Supply	on the rear	on the rear	on the front	on the rear	on the rear
Screw terminals	16 – 50 mm ² AWG 5 – AWG 1	16 – 50 mm ² AWG 5 – AWG 1	4 – 25 mm ² AWG 11 – AWG 3	16 – 50 mm ² AWG 5 – AWG 1	16 – 50 mm ² AWG 5 – AWG 1
Tightening torque	6 ... 8 Nm	6 ... 8 Nm	4 ... 4.5 Nm	6 ... 8 Nm	6 ... 8 Nm
Loads					
Max. load current per load terminal	30 A with 9 ways	30 A with 9 ways	30 A with 9 ways	30 A with 19 ways	30 A with 2 x 9 ways
Terminals	on the rear	on the front	on the front	on the rear	on the rear
Screw terminals	0.5 – 6 mm ² AWG 20 – AWG 10	–	–	0.5 – 6 mm ² AWG 20 – AWG 10	0.5 – 6 mm ² AWG 20 – AWG 10
SUB-D connector	–	2.5 – 10 mm ² AWG 13 – AWG 7	2.5 – 10 mm ² AWG 13 – AWG 7	–	–
Tightening torque	0.5 ... 0.8 Nm	–	–	0.5 ... 0.8 Nm	0.5 ... 0.8 Nm
Signalling					
Group signalling	Group signalling possible by means of optional RSI10 sub-assembly				
Grounding					
Ground connector	M6 ground stud, always on the rear, tightening torque 6 Nm				

Table 2: Selection of technical data

*) For further information please see the relevant data sheet.

3.3 Scope of delivery *Power-D-Box*[®] CP

The following parts are part of the delivery scope of the *Power-D-Box*[®] CP:

- 19" rack with 19" / ETSI interchangeable flange (mounted 19")
- blanking pieces for slots of circuit protectors and control interface (mounted)
- mating plugs in the event of rear screw terminals (plugged on). Versions: PDB- P-CPxxx-xR-Ax

3.4 Optional accessories *Power-D-Box*[®] CP

The following accessories can be ordered separately:

- rear cable grip rail part no. X22326001
- connector set, high current SUB-D for load terminal on the front part no. X22318901
- marking frame with labels, 0.5U, for customised marking of circuit protectors part no. X22357501
- marking frame with labels, 1 U with cable gland on the front,
for customised marking of the circuit protectors part no. X22357601
- extracting tool ESS300-S part no. X22385301
- parallel connection of several ESX300-S *Plus* (for two ESX300-S) part no. X22387411
- parallel connection of several ESX300-S *plus* (for three ESX300-S) part no. X22387401
- circuit protectors, type ESX300-S-3xx-xxA
- signalling sub-assembly RSI10-xxx-x
- RCI10-xxx-x control interface
- control alarm interface EAI300-S-xxx-x

For more information on accessories please see the data sheet of *ControlPlex*[®] Rack.

3.5 Pictures of *Power-D-Box*[®] CP versions (front view)



fig. 1: Front view PDB-P-CP18R-RR-A, PDB-P-CP19A-RR-Ax



fig. 2: Front view PDB- P-CP09A-RR-Ax

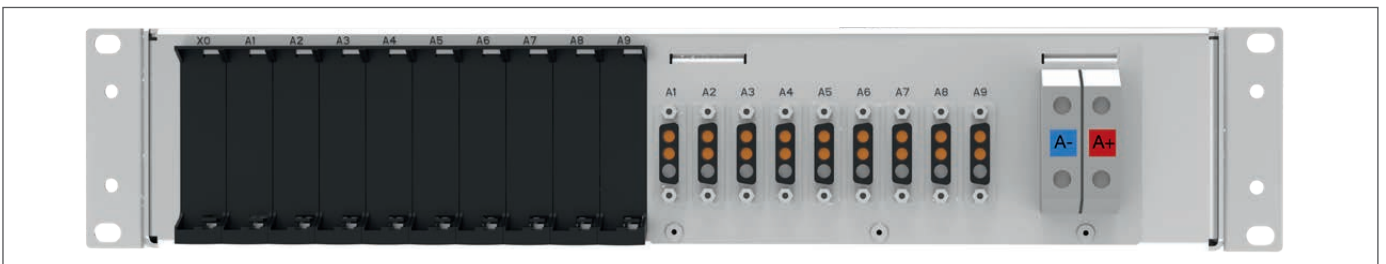

fig. 3: Front view PDB- P-CP09A-FF-Ax terminals on the front with high current SUB-D connectors

3.6 Drawings and dimensions of *Power-D-Box*[®] CP versions

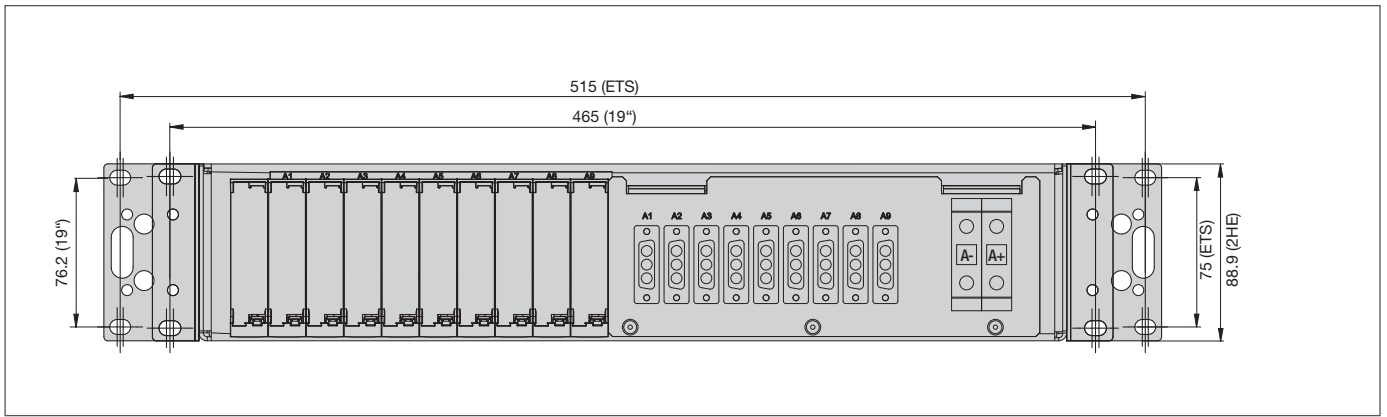

fig. 4: Front view PDB- P-CP09A-FF-Ax 1 x 9 slots, terminals on the front with high current SUB-D connectors

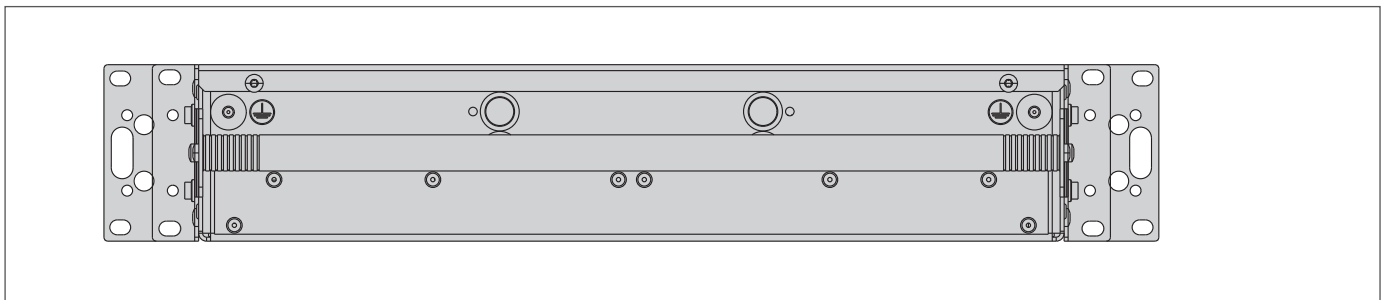

fig. 5: Rear view PDB- P-CP09A-FF-Ax 1 x 9 slots (with rear cable grip rail)

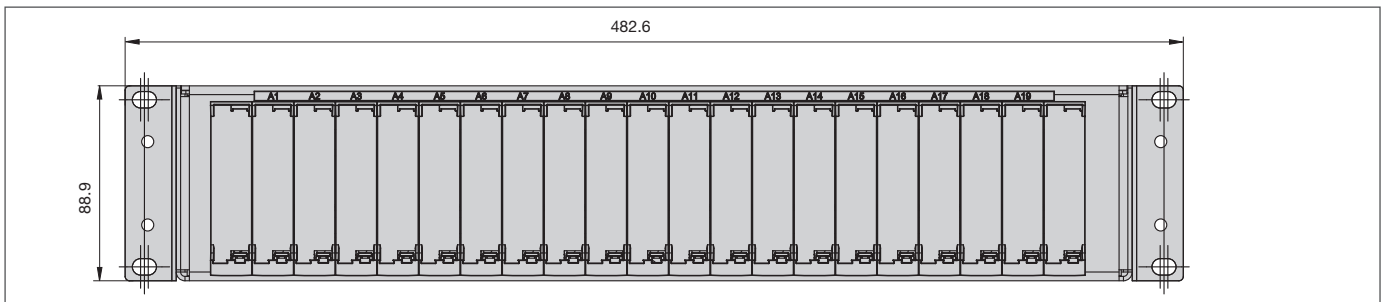

fig. 6: Front view PDB-P-CP19A-RR-Ax, 1 x 19 slots

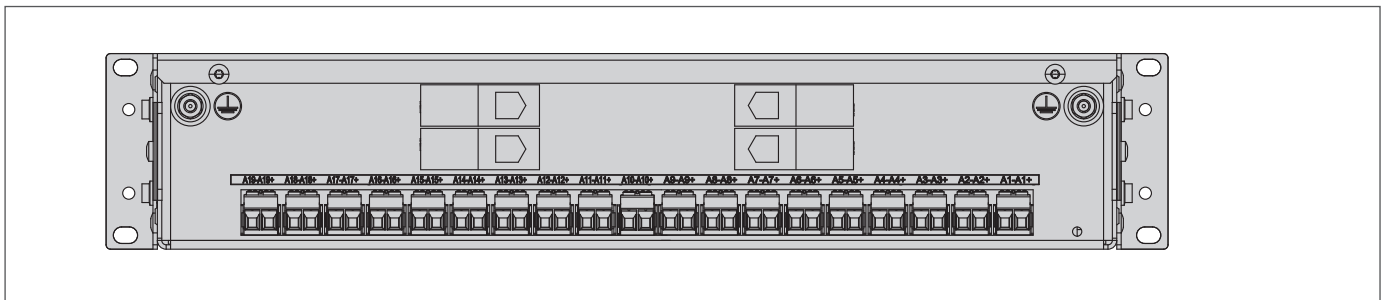

fig. 7: Rear view DB- P-CP19A-RR-Ax without cable grip

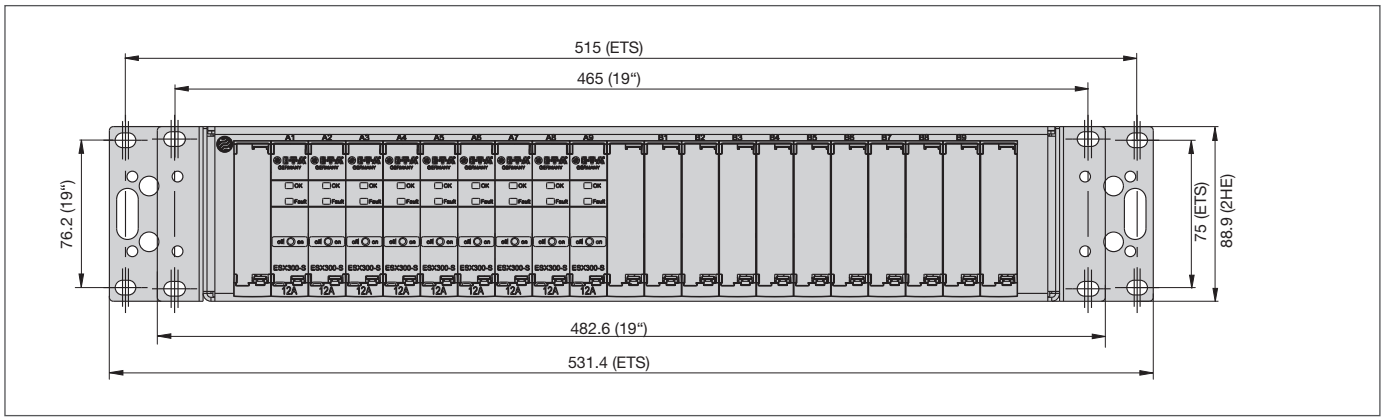

fig. 8: Front view PDB- P-CP18R-RR-Ax 2 x 9 slots

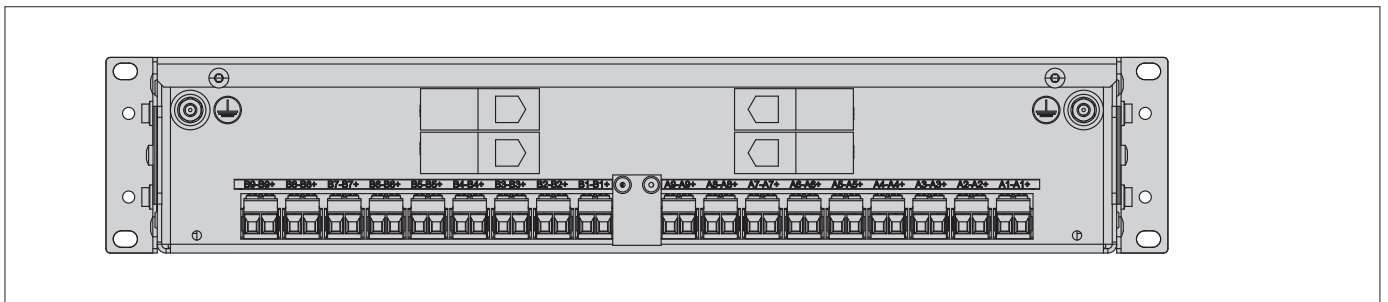

fig. 9: Front view PDB- P-CP18R-RR-Ax 2 x 9 slots

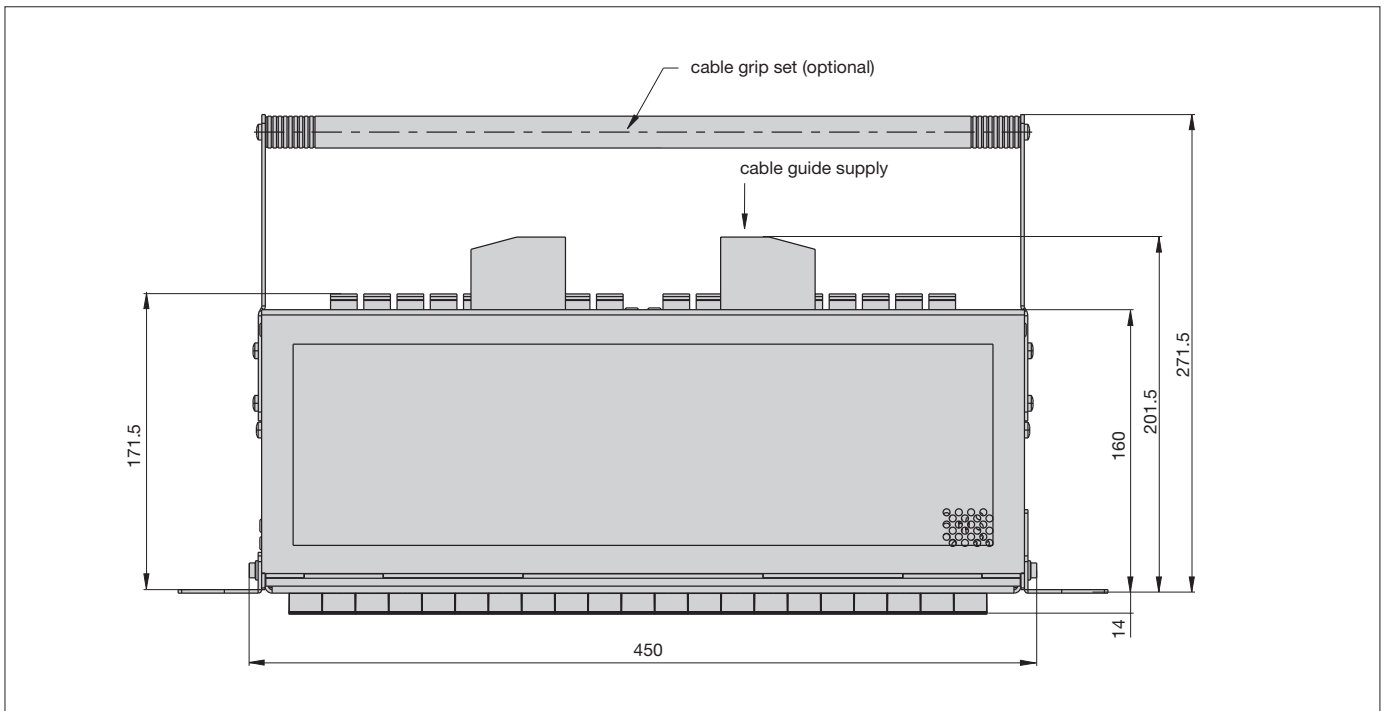

fig. 10: Top view PDB- P-CP18R-RR-Ax 2 x 9 slots (with rear cable grip rail)

3.7 Schematic diagrams of Power-D-Box® CP versions

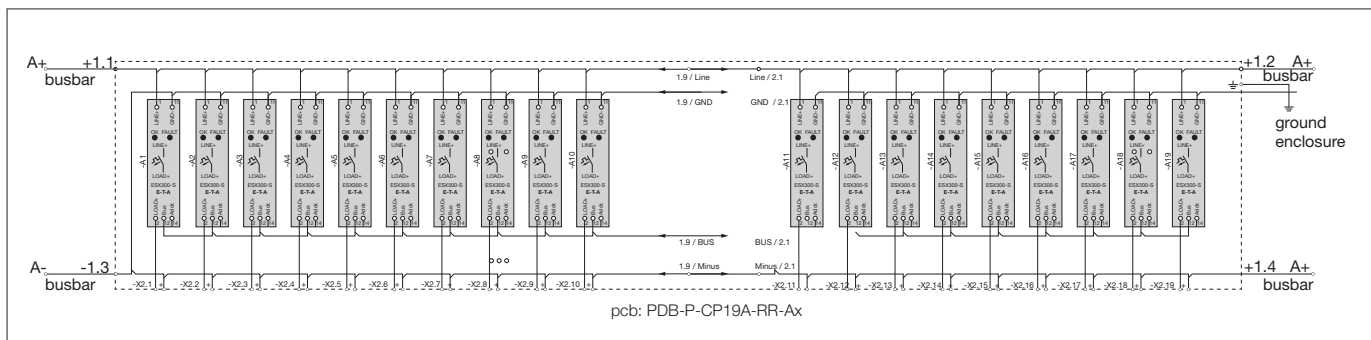

fig. 11: Schematic diagram PDB- P-CP19A-RR-Ax, 1 x 19 slots with signalling

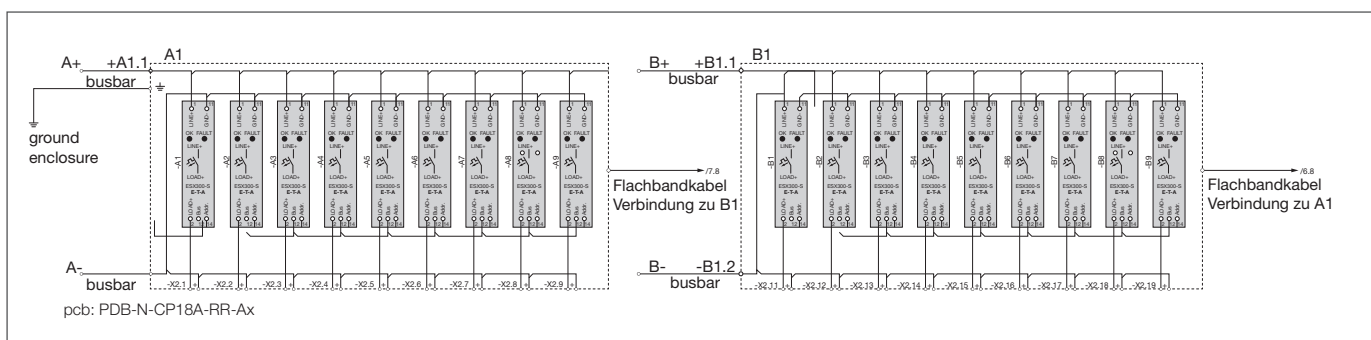

fig. 12: Schematic diagram PDB- P-CP18R-RR-Ax, 2 x 9 slots with signalling

3.8 Pin assignment of Power-D-Box® CP versions

Pin assignment PDB- P-CP09A-RR-Ax, PDB- P-CP18R-RR-Ax

- rear-side supply terminals DC 24 V, DC 24 V, DC 60 V/max. 2 x 150 A
- cable cross section max. 50 mm²

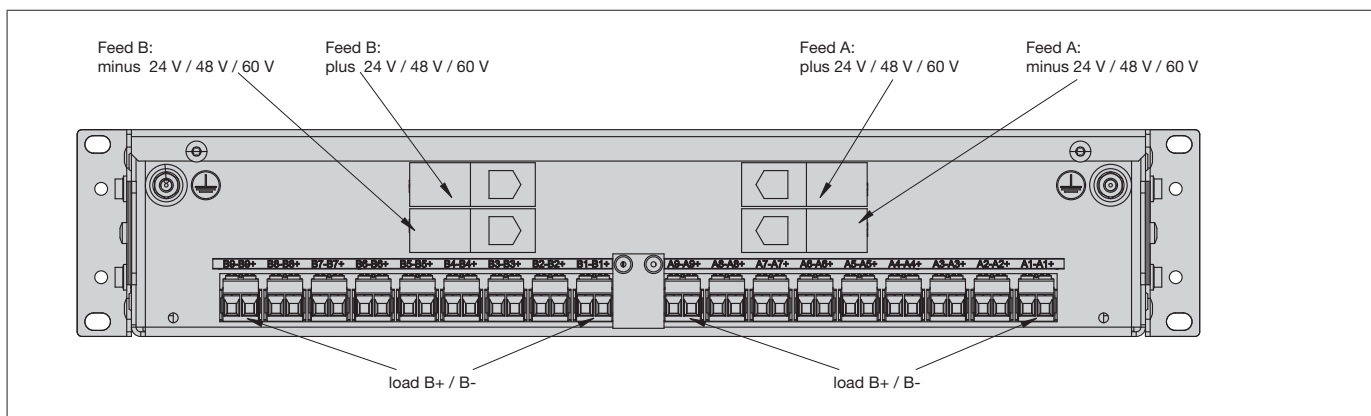

fig. 13: Version PDB- P-CP18R-RR-A, pin assignment (cable grip removed/Minus version)

Pin assignment PDB- P-CP09A-FF-Ax

- front-side supply terminals DC 24 V, DC 24 V, DC 60 V/max. 100 A
- cable cross section max. 25 mm²
- load terminals A1 ... A9 (on the front) DC 24 V, DC 48 V, DC 60 V/max. 30 A
- cable cross section max. 10 mm²

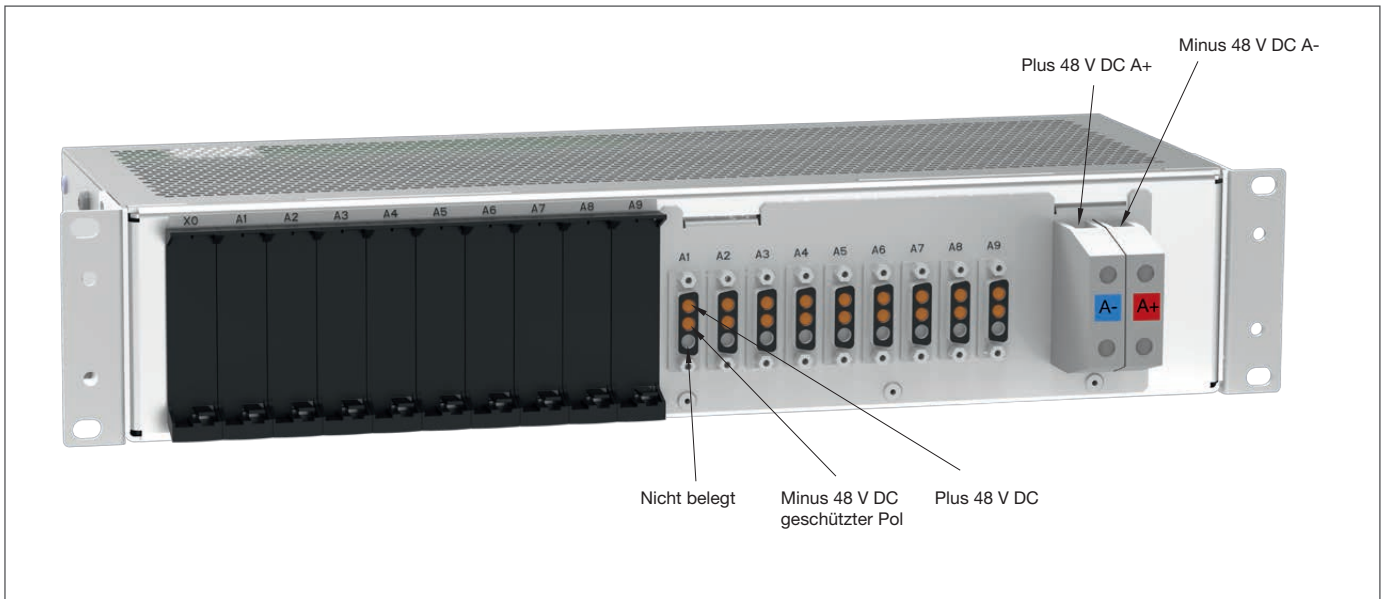

fig. 14: Version PDB- P-CP09A-FF-Ax, pin assignment

Pin assignment PDB-P-CP09A-RF-Ax

- line entry see PDB-P-CP09A-RR-Ax
- load terminals see PDB-P-CP09A-FF-Ax

Pin assignment PDB-P-CP19A-RR-Ax

- rear-side supply terminals DC 24 V, DC 24 V, DC 60 V/max. 200 A with supply via both supply terminals (internally bridged) Max. 150 A bei 50 mm² Kabelquerschnitt per supply terminal.
- cable cross section max. 50 mm² per supply.
- cable cross section max. 4mm² with wire end ferrule per load terminal

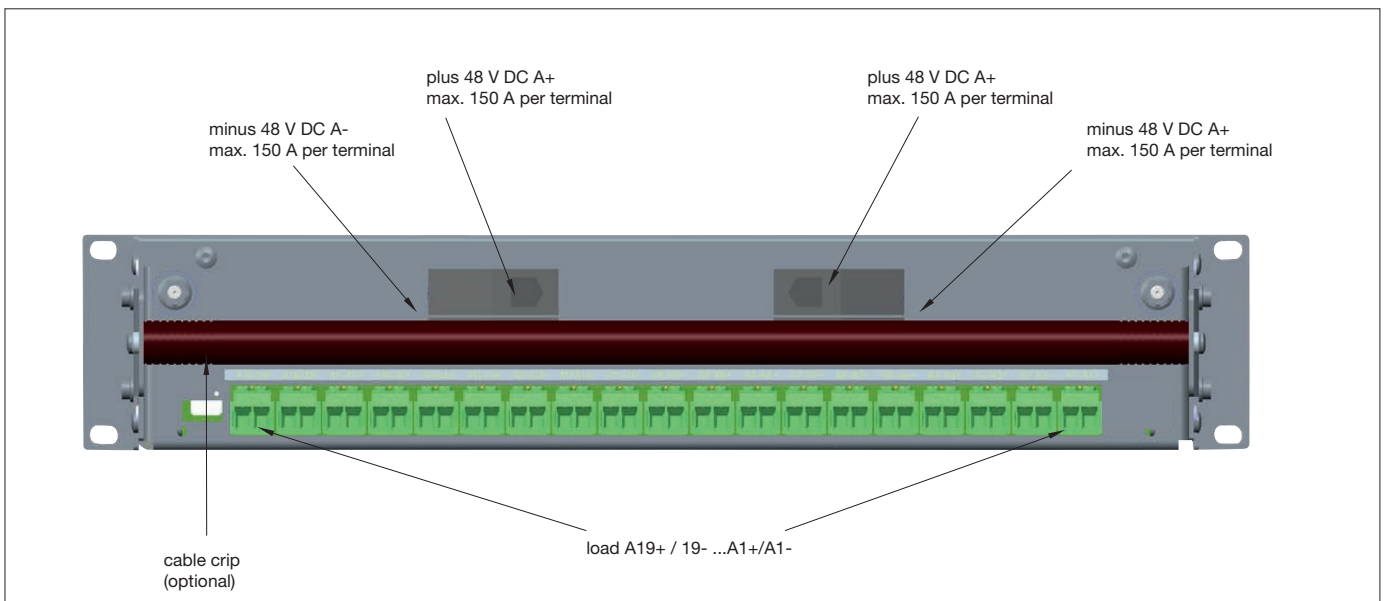

fig. 15: Version PDB- P-CP19A-RR-Ax, pin assignment (cable grip installed)

3.9 Installation and start-up of the *Power-D-Box*[®] CP

The *ControlPlex*[®] Rack system has been designed for stationary installation in an indoor system cabinet. For installation in an outdoor cabinet we recommend a fully conditioned cabinet with heating and cooling. In the event of high humidity the surrounding has to be additionally dried.

3.9.1 Recommended installation site for *Power-D-Box*[®] CP

Usually the *Power-D-Box*[®] CP is installed in the top or bottom area of the system rack. We recommend installation in close proximity to the connected loads so as to reduce wiring and cable management.

Important:



- Leave sufficient space for heat dissipation, min. 0.5U above or below the *Power-D-Box*[®] CP should be free for ventilation.
- Please take care to install the *Power-D-Box*[®] CP in enclosed and dry rooms.
- Please observe the required degree of protection.

GENERAL REQUIREMENTS OF INSTALLATION SITE

Various aspects have to be considered when choosing the installation site.

	Ventilation Please ensure sufficient ventilation by leaving enough space at all sides of the device and ensure that the vent holes are not blocked. Leave enough space between the devices.
	Cable management Ensure installation at a site where the cables can be laid and connected properly. Ensure ease of access for service and system extensions of all termination versions even after installation.
	Electrical noise pulses The installation site should provide sufficient distance to any devices that might emit noise pulses

Table 3: *Power-D-Box*[®] CP requirements of installation site

3.9.2 Basic notes on wiring of *Power-D-Box*[®] CP

The selection of the correct cable types regarding temperature resistance and ampacity is important for the reliable power distribution, control and monitoring by means of a *ControlPlex*[®] Rack system. Please ensure to use cables of superior quality with the suitable cross sections so as to avoid voltage drops.

Laying of cables must be carried out carefully. The table 4 gives general hints regarding wiring of a *Power-D-Box*[®] CP, including the connected loads.

1	Cables must be protected against damages and heat. Avoid the proximity to moveable or hot parts and to machines.
2	Ensure a suitable strain relief.
3	Check cables with regard to intact insulation, above all after cable installation.

Table 4: *Power-D-Box*[®] CP wiring hints

3.9.3 Installation and start-up of the *Power-D-Box*[®] CP







	<p>Danger: Turn off the supply voltage Before beginning with installation, the system has to be disconnected from the mains. A cable connection must only be established if the supply voltage is OFF.</p>
	<p>Caution: Work with ESD protection To protect electronic components against electrostatic voltage, any work must only be carried out with corresponding ESD protection means. Failure to comply can cause damages on the <i>ControlPlex</i>[®] Rack system or the corresponding components.</p>
	<p>Warning: Mounting position The <i>Power-D-Box</i>[®] CP must only be installed horizontally in the cabinet, vertical installation may cause overheating.</p>
	<p>Warning: Supply voltage Voltage of the power supply has to be between DC 20 V and DC 72 V to ensure faultless operation. In the event of a voltage in excess of DC 75 V the <i>Power-D-Box</i>[®] CP may be damaged.</p>

Table 5: *Power-D-Box*[®] CP Important hints for start-up

Start-up of the *Power-D-Box*[®] CP comprises the following steps:

Step	Action
1	<p>Prepare all necessary devices and tools such as:</p> <ul style="list-style-type: none"> • different screw drivers and M6 box wrench (not delivered with product) • connecting cables for power supply and ground (not delivered with product) • connecting cables for load terminals (not part of the delivery scope) • 4 mounting screws M6 x 16 mm with plastic sleeve • 2 x M6 cable lug, not part of the delivery scope (ground connection <i>Power-D-Box</i>[®] CP) • Load terminal mating plug (can be ordered as accessory for version with front connection, otherwise it is part of the <i>Power-D-Box</i>[®] CP delivery scope)
2	<p> If installation shall be in an ETSI rack: Re-work of the <i>Power-D-Box</i>[®] CP mounting brackets to ETSI dimensions: remove, turn bracket by 180°, re-tighten with the 2 mounting screws.</p>
3	<p>Important: Please ensure that the system is dead-voltage.</p>
4	<p> Please install all required cables for ground, Supply and load terminals of the <i>Power-D-Box</i>[®] CP.</p>
5	<p>Connect the load connection cables with the corresponding load connectors and mark them with the corresponding channel no. of the <i>Power-D-Box</i>[®] CP. Important: Do not yet connect the load connector with the <i>Power-D-Box</i>[®] CP.</p> <ul style="list-style-type: none"> - depending on the version, see chapter 3.7 pin assignment - depending on the version, tightening torque value of supply terminals, see table 2, »Technical data / supply«
6	<p>Mounting of <i>Power-D-Box</i>[®] CP in the system cabinet: Install the <i>Power-D-Box</i>[®] CP horizontally in the system cabinet and fix it with the 4 supplied mounting screws. The tightening torque of the mounting screws is 5.3 – 5.7 Nm.</p>
7	<p>Connection of the <i>Power-D-Box</i>[®] CP grounding cable(s): The ground connection is on the rear side of the <i>Power-D-Box</i>[®] CP (see fig. 15) and is marked with a grounding symbol. In the event of two separate power supplies (redundant system) both ground connections have to be connected with one grounding cable each. The grounding cable can be fixed with an M6 cable lug and the fitted grounding nut with a tightening torque of 6 Nm.</p>



8	<p>Connection of the <i>Power-D-Box</i>[®] CP supply lines:</p> <ul style="list-style-type: none"> - depending on the version, see chapter 3.8 pin assignment - depending on the version, tightening torque value of supply terminals, see table 2, »Technical data / supply« <p>Important: Do not yet connect any load lines.</p>
9	<p>Switch on the power supply.</p> <p>Check correct polarity with a voltmeter (plus, minus) and the correct voltage value of the power supply terminals. In the event of a failure please remedy before proceeding with step 10.</p>
10	<p> For installation of the electronic circuit protectors, please go to chapter 4: »ControlPlex[®] Rack, electronic circuit protector ESX300-S«</p>
11	<p> For installation as group alarm indicator (population without circuit protectors, only with alarm interface EAI300) please go to chapter 8 »ControlPlex[®] Rack, E/A external alarm interface EAI300«</p>

Table 6: Power-D-Box[®] CP steps for start-up

4 ESX300-S electronic circuit protector *plus*

The electronic circuit protector ESX300-S *Plus* has particularly designed for the use in the **Power-D-Box® CP** of type PDB-P-CP. It can be installed and de-installed with the system live without having to disconnect the application from the mains. Thus you can reduce the installation and service periods to a minimum.

4.1 Application ESX300-S *plus*

The electronic circuit protector ESX300-S *plus* is suitable for plus supplied systems with voltage ratings DC+24 V, DC + 48 V, DC +60 V. It is capable of disconnecting all faulty loads selectively in the event of overcurrent and short circuit, i.e. without voltage dip or failure of neighbouring loads. In the event of overcurrent or short circuit the active current limitation of the ESX300-S *plus* prevents an overload-dependent voltage regulation of the (switched mode) power supply.

In the event of a failure the latter prevents a voltage dip of the switch-mode power supply and thus repercussions on the neighbouring loads. The ESX300-S *plus* is available with bus interface. The ESX300-S *plus* in connection with the signalling sub-assembly RSI10 (see chapter 6) or with the control interface RC110 (see chapter 7) allows failure indication as well as an automatic remote control of the ESX300-S *plus* via a controlling computer.

4.2 Technical data ESX300-S *plus*

Electronic circuit protectors with active current limitation for use in plus-supplied equipment.

Technical data ($T_{amb} = 25\text{ °C}$, $U_B = \text{DC } 48\text{ V}$)	
Rated voltage U_B	DC +24 V, DC +48 V, DC +60 V (adjustable via slide switch)
Current rating range I_N	2 A / 5 A / 8 A / 12 A / 16 A* / 20 A* / 24 A*
* Parallel connection of several ESX300-S <i>plus</i> (only available for CP with load outputs on the rear)	16 A / 20 A / 24 A can be connected in parallel by means of jumpers so that loads up to 60 A can be protected.
Power consumption I_0	typically 16 mA
Trip current	typically $1.2 \times I_N$
Low voltage monitoring	Factory setting: typically (18 V < U) 24 V typically (40 V < U) 48 V typically (54 V < U) 60 V
Overvoltage monitoring	Factory setting: typically (30 V < U) 24 V typically (57 V < U) 48 V typically (72 V < U) 60 V
Load circuit	
Load output	Power MOSFET switching output (plus switching), no physical isolation
Trip times	typically < 20 ms at short circuit typically < 30 sec. at overcurrent
Inductive load	external free wheeling diode recommended
Capacitive load	max. 7,000 μF
Temperature disconnection	typically at $T_{amb} = 105\text{ °C}$
Status indication/momentary switch (operating conditions see table 1)	
Status LEDs	red, green
Momentary switch	switch on and off
General data	
Leakage current in the off state	typically 1 mA
Back-up fuse	not required due to integral fail-safe element
Environmental conditions	
Ambient temperature	-20 °C ... +55 °C without condensation see EN50240-1
Storage temperature	-20 °C ... +70 °C
Humidity	96 hours at 95% RH, 40 °C, to IEC 60068-2-78, climate class 3K3 to EN60721

Marking and approvals	
ESD	4 kV/air 8 kV
EMC requirements	to EN 61000-6-3 / EN 61000-6-2
Vibration resistance	3 g to IEC 60068-2-6,
Marking	CE in accordance with EMC directive (EN 61000-6-3 & EN 61000-3-2)
Conformity	UL2367, EN 60950-1 / UL 60950-1 (when installed / in PDB)

Table 7: For the ESX300-S plus is identical with 4.2.1

4.2.1 Current rating, voltage drop and load capacity of ESX300-S plus

current rating range I_N	typical voltage drop U_{ON} at I_N	active current limitation typically	trip time typically at $1.2 \times I_N$	fail-safe element	max. load current at 100% ON duty		max. capacitive load (μF)
					$T_{AMB} = 40 \text{ }^\circ C$		
2 A	130 mV	$1.20 \times I_N$	0.2 – 3 s	4 A	2 A	1500	
5 A	130 mV	$1.20 \times I_N$	0.2 – 3 s	10 A	5 A	2000	
8 A	200 mV	$1.20 \times I_N$	0.2 – 3 s	10 A	8 A	3000	
12 A	150 mV	$1.20 \times I_N$	0.2 – 3 s	20 A	12 A	4000	
16 A	200 mV	$1.20 \times I_N$	0.2 – 3 s	20 A	16 A	5000	
20 A	160 mV	$1.20 \times I_N$	0.2 – 3 s	30 A	20 A	6000	
24 A	200 mV	$1.20 \times I_N$	0.2 – 3 s	30 A	24 A	7000	
32 A* (2 x 16 A)	200 mV	$1.20 \times I_N$	0.2 – 3 s	2 x 20 A	32 A	10000	
40 A* (2x 20 A)	160 mV	$1.20 \times I_N$	0.2 – 3 s	2 x 30 A	40 A	12000	
44 A* (2 x 24 A)	200 mV	$1.20 \times I_N$	0.2 – 3 s	2 x 30 A	44 A	14000	
48 A* (3 x 16 A)	200 mV	$1.20 \times I_N$	0.2 – 3 s	3 x 20 A	48 A	15000	
60 A* (3 x 20 A)	160 mV	$1.20 \times I_N$	0.2 – 3 s	3 x 30 A	60 A	18000	
60 A* (3 x 24 A)	200 mV	$1.20 \times I_N$	0.2 – 3 s	3 x 30 A	60 A	21000	

Note: The total current of neighbouring devices must not exceed 44 A. The derating factor at an ambient temperature of $> 40 \text{ }^\circ C$ is 0.8 times rated current.

Table 8: Current ratings, voltage drop and load capacity

*higher current rating through parallel connection of several ESX300-S

4.2.2 LED status Indication and operating conditions

operating condition	load output	LED green	LED red
No error -> OFF	locked	flashing slowly	OFF
Normal operation	connected	ON	OFF
Error undervoltage with device OFF (18 V < U) 24 V (40 V < U) 48 V (54 V < U) 60 V	locked	OFF	ON
Error overvoltage with device OFF (30 V < U) 24 V (57 V < U) 48 V (72 V < U) 60 V	locked	OFF	ON
Overcurrent error detected ($I > I_N < 1.2 \times I_N$) overcurrent failure has to be detected for approx. 30 seconds before disconnection is effected	connected	ON	flashing fast
Error - overcurrent or short circuit disconnection	locked	OFF	ON
Error undervoltage (18 V < U) 24 V (40 V < U) 48 V (54 V < U) 60 V	connected	ON	ON
Error overvoltage (30 V < U) 24 V (57 V < U) 48 V (72 V < U) 60 V	connected	ON	ON
Error, no voltage or internal error	locked ¹	OFF	OFF
Error high temperature	locked ¹	OFF	flashing slowly
Remote disconnection	locked	flashing fast	OFF

Table 9: LED status Indication and operating conditions

4.3 Scope of delivery ESX300-S plus

The following parts are part of the delivery scope of the ESX300-S plus:

- Electronic circuit protector, type: ESX300-S-xxx-xxA with front plate

4.4 Picture ESX300-S plus

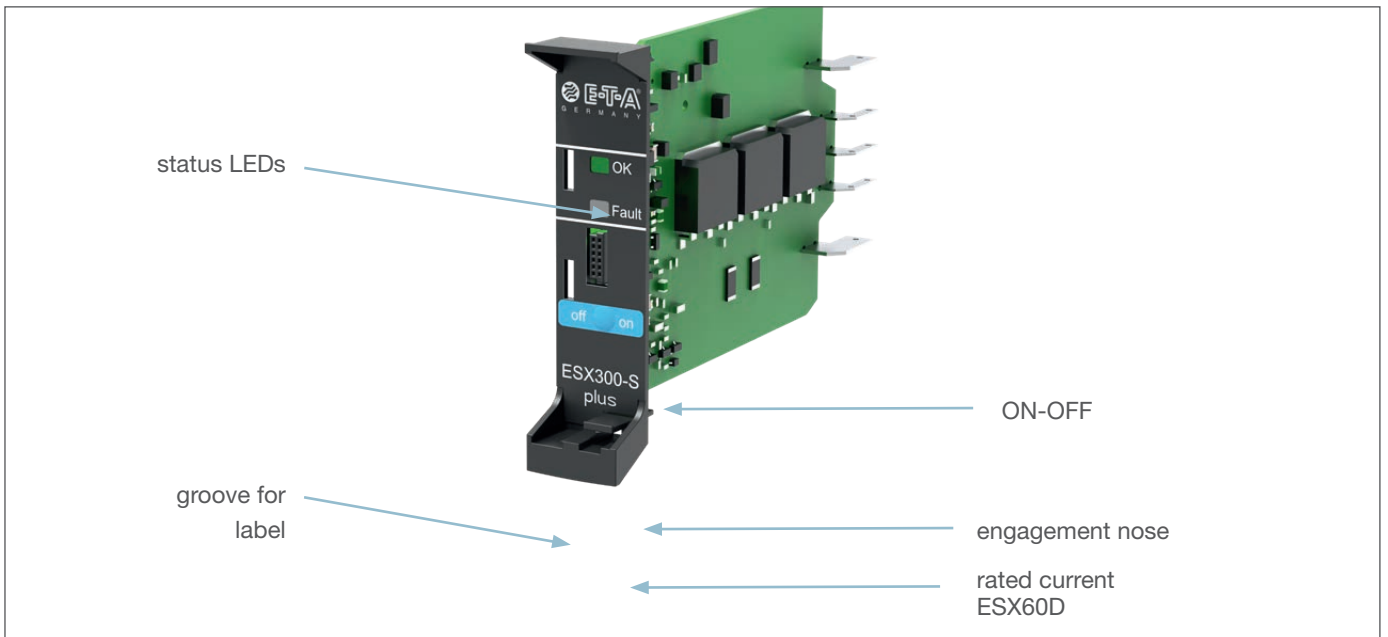

fig. 16 ESX300-S plus circuit protector

4.5 Installation and start-up ESX300-S plus

Important notes

	<p>Note: Power-D-Box® CP installed Before starting the installation, the Power-D-Box® CP has to be properly installed first and supply voltage should be applied. All steps in chapter 3 were carried out properly.</p>
	<p>Caution: Work with ESD protection To protect electronic components against electrostatic voltage, any work must only be carried out with corresponding ESD protection means. Failure to comply can cause damages on the ControlPlex® Rack system or the corresponding components.</p>
	<p>Warning: Mounting position The ESX300-S sub-assembly has to be pushed in vertically into the Power-D-Box® CP.</p>
	<p>Warning: load terminal Load terminal must be open (not connected) when installing the ESX300-S.</p>
	<p>Warning: Supply voltage The voltage of the power supply must be between DC 20 V and DC 72 V to ensure a smooth operation. In the event of a voltage in excess of DC 75 V the electronic circuit protector may be damaged.</p>

Table 10: ESX300-S, important hints for start-up

4.6 Configuration of the voltage range with ESX300-S plus

Voltage of the ESX300-S *plus* must be set before installation in the **ControlPlex® Rack** corresponding to the supply voltage of the power supply. For this purpose, the slide switch on the pcb of the ESX300-S *plus* must be moved to the proper position. Condition as delivered of the ESX300-S *plus* is 48 V. Depending on the configured voltage range, the voltage specification for undervoltage or overvoltage detection will change as well. (see chapter 4.2.2)

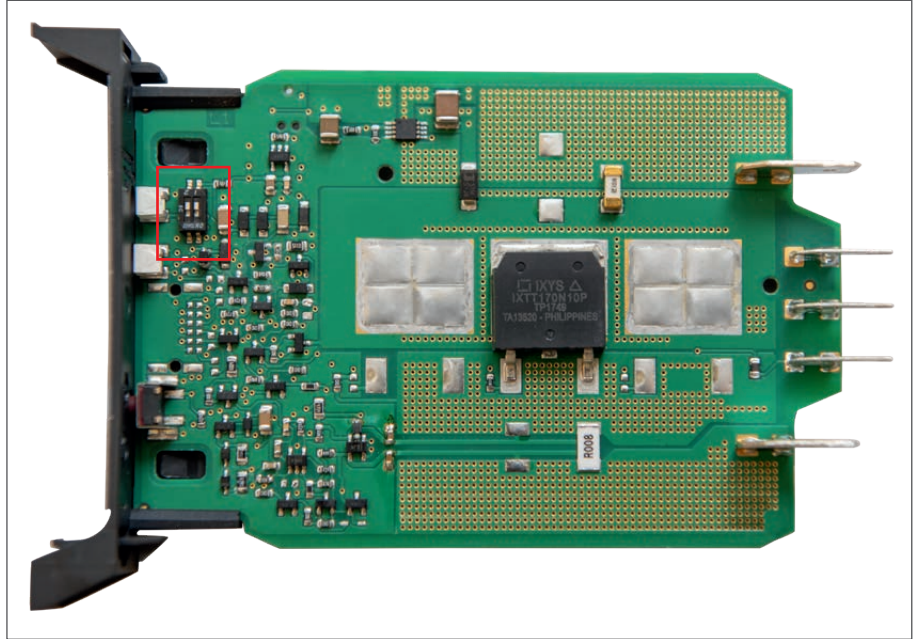

fig. 17: ESX300-S plus with slide switch to adjust voltage rating

	<p>ESX300-S <i>plus</i> slide switch position for rated voltage 48 V (condition as delivered)</p>
	<p>ESX300-S <i>plus</i> slide switch position for rated voltage 24 V</p>
	<p>ESX300-S <i>plus</i> slide switch position for rated voltage 60 V</p>

Table 11: Slide switch positions of the different voltage ratings of the ESX300-S plus

Start-up of the ESX300-S comprises the following steps:





step	action
1	<p>Prepare all necessary devices and tools such as:</p> <ul style="list-style-type: none"> • Electronic circuit protectors ESX300-S (check the ESX300-S with regard to the required current ratings, see chapter 4.2.1 fig. 16 »rated current« • Please check if you adjusted the voltage range of the ESX300 plus in accordance with your power supply. (see chapter 4.8) • For use with PDB-N-CPxxx-xx-Ax (new version of the Power-D-Box® CP), bus-capable circuit protectors such as ESX300-S-3xx are compulsory. 
2	 <p>Danger: Please make sure that all steps in chapter 3 describing start-up of Power-D-Box® CP are carried out correctly and faultlessly.</p>
3	 <p>Warning: The total current of neighbouring circuit protectors must not exceed 44 A. The derating factor is 0.8 times rated current of the ESX300-S with ambient temperatures > 40 °C.</p>
4	<p>Installation of ESX300-S circuit protectors in the Power-D-Box® CP: Push the ESX300-S with the correct current rating carefully into the related and documented slot (e.g.: slot A1) and push until the front plate latches into the Power-D-Box® CP.</p>
5	<p>Check the LED indication of the installed ESX300-S: The status LED »OK« must blink green (load output not yet connected). If the green LED is lighted continuously, push the »On/Off« momentary switch once until it blinks. Important: The red status LED »Fault« must be off. If this is not the case, please go to chapter 4.7 ESX300-S trouble-shooting and remedy the failure. Do not continue with step 6 before the LED status indication (both LEDs) is as described in step 5.</p>
6	<p>Connection of load output to corresponding load channel of the Power-D-Box® CP: Important: Check correct polarity (plus/minus) before connecting. Plug in the load terminal connector pertinent to the installed ESX300-S slot. Example: ESX300-S slot A1 is assigned to load connector A1+ / A1-</p>
7	<p>Switch on the load output of the ESX300-S: Push the momentary switch »On/Off« of the installed ESX300-S circuit protectors. LED status indication: Green LED »OK« is lighted permanently, red LED »Fault« is off. If the LED indication is different from the description, please go to chapter 4.7 ESX300-S trouble-shooting.</p>
8	<p>Optional: Individual marking of ESX300-S with the name intended for it. This can be done either on the small label of the ESX300-S or by means of the marking bar available as accessory.</p>
9	<p>Repeat step 1 – 8 for each ESX300-S to be installed.</p>
10	 <p>Optional: If additional population with E/A external alarm interfaces EAI300, please go to chapter 7 »ControlPlex® Rack, E/A external alarm interface EAI300«</p>
	<p>END</p>

Table 12: Start-up of ESX300-S

4.7 Removal of the ESX300-S electronic circuit protector *plus*

4.7.1 Removal of the ESX300-S electronic circuit protector *plus* without extracting tool

The electronic circuit protectors can be removed as follows:



step	action	
	Caution: Work with ESD protection To protect electronic components against electrostatic voltage, any work must only be carried out with corresponding ESD protection means. Failure to comply can cause damages on the ControlPlex® Rack system or the corresponding components.	
1		Important: The ESX300-S has to be in the OFF condition before being removed. <ul style="list-style-type: none"> • Push the momentary switch »On/Off« until the green status LED »OK« is blinking slowly or • switch the Power-D-Box® CP dead-voltage (both LEDs off)
2		When removing the electronic circuit protector, the interlock at the bottom of the front plate of the circuit protector must be pushed down (see fig. 17).
3	Hold down the interlock and remove the circuit protector by pulling simultaneously at the handles on the top and the bottom of the front plate (see fig. 18).	
END		

Table 13: Removal ESX300-S

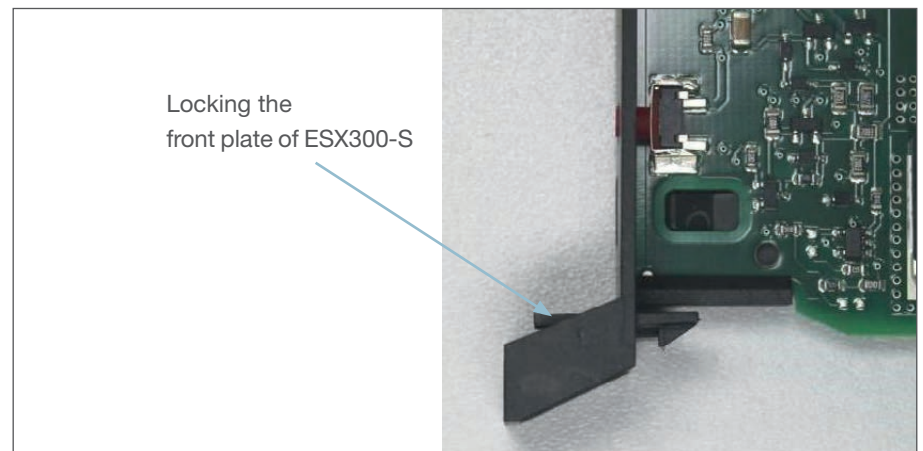

fig. 18: ESX300-S interlock

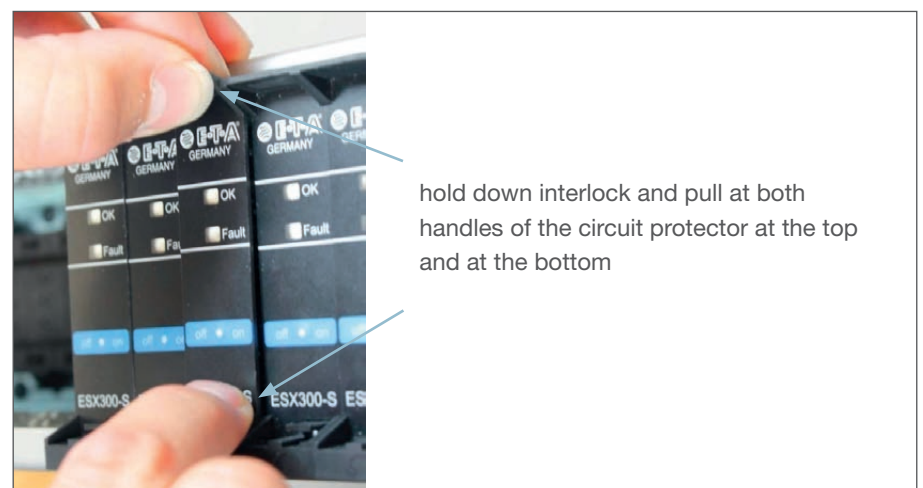

fig. 19: ESX300-S removal

4.7.2 Removal of the ESX300-S electronic circuit protector *plus* with the extracting tool

The electronic circuit protectors can be removed as follows:



step	action
	Caution: work with ESD protection. To protect electronic components against electrostatic voltage, any work must only be carried out with corresponding ESD protection means. Failure to comply can cause damages on the ControlPlex® Rack system or the corresponding components.
1	 Important: The ESX300-S has to be in the OFF condition before being removed. Push the momentary switch »On/Off« until the green LED »OK« blinks slowly or disconnect the Power-D-Box® CP (dead-voltage, both LEDs off).
2	 When removing the electronic circuit protector, the interlock at the bottom of the front plate of the circuit protector must be pushed down. (see fig. 18)
3	Place the extraction tool in the recess on the left side of the ESX300-S. Then push the extraction tool together with two fingers (see fig. 1) and pull out the circuit protector.
	END

Table 14: Removal of type ESS30-S with extraction tool

An extracting tool for easy removal of the ESX300-S *plus* is optionally available. For more information see page 11.

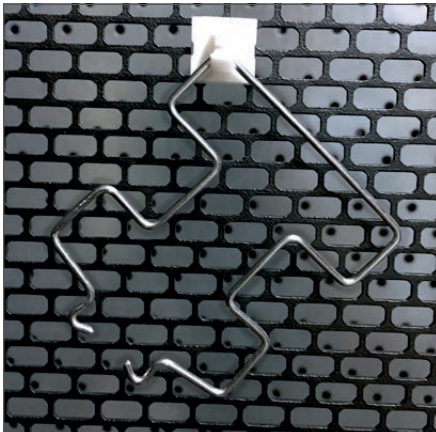

fig. 20: Delivery scope extracting tool for ESX300-S with mounting bracket

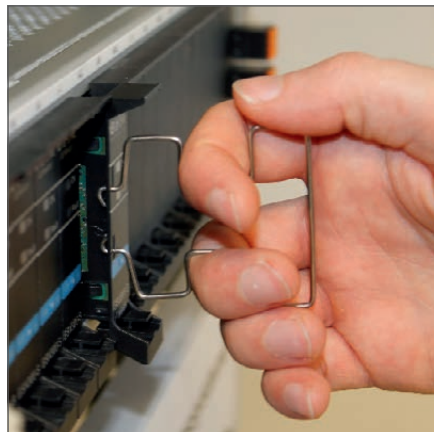

fig. 21: Extracting tool for ESS300-S

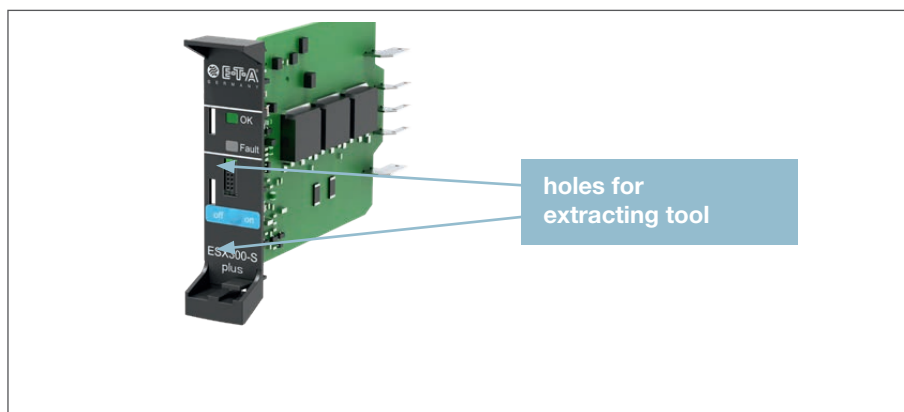

fig. 22: Holes for extracting tool

4.8 Troubleshooting concerning electronic circuit protector ESX300-S

The electronic circuit protector ESX300-S has two status LEDs allowing a comprehensive failure analysis in the event of a failure. Please proceed as follows for trouble-shooting:

Important notes



	<p>Caution: Work with ESD protection To protect electronic components against electrostatic voltage, any work must only be carried out with corresponding ESD protection means. Failure to comply can cause damages on the ControlPlex® Rack system or the corresponding components.</p>
	<p>Special precautions must be taken in the system or machine which reliably prevent an automatic re-start of moveable parts of the system (cf. Machinery Directive 98/37/EG and EN 60204-1, Safety of Machinery).</p>
	<p>Note: ESX300-S time after short circuit or overcurrent trip After tripping due to a short circuit, the circuit protector ESX300-S can only be reset after a delay time of approx. 20 seconds.</p>

Table 15: Hints for trouble-shooting for ESX300-S

What to do in the event of a failure

step	action
1	<p>Check status indication of ESX300-S: Check the status of the LEDs of the ESX300-S by table 9, chapter 4.2.2 and put down the cause of the failure</p>
2	<p>Depending on the cause of the failure you can establish physical isolation of the faulty circuit by pulling out the ESX300-S see chapter 4.6 Removal of the electronic circuit protectors.</p>
3	<p>Remedy the cause of the failure As described in step 1, e.g. short circuit on load</p>
4	<p>Re-install the ESX300-S after remedy of the failure see chapter 4.5 Start-up of ESX300-S</p>
	<p>END</p>

Table 16: Trouble-shooting ESX300-S

5 Parallel connection of several ESX300-S plus

5.1 Application of parallel connection of several ESX300-S plus

By connecting several ESX300-S in parallel, loads > 24 A can be protected. This functionality is available for the current ratings 16 A, 20 A and 24 A of the ESX300-S plus or ESX300-S minus. Parallel connection of the ESX300 can be configured both at no voltage condition of the box as well as under voltage.

5.2 Technical data load bridge for parallel connection of several ESX300-S plus

Technical data:	
Design of load bridge	Plug-in type printed circuit board with screw terminals for the load outputs.
Terminals	Plug-in type screw terminal cable cross section 0.2 mm ² ... 16 mm ²
Degree of protection	IP20
Mass	X22387411 (2-way) 58 g X22387401 (3-way) 66 g
Terminal of load bridge	
Tightening torque, min.	1.2 Nm
Tightening torque, max.	1.5 Nm
Suitable conductors	
panel thickness, min.	0.2 mm ²
panel thickness, max.	16 mm ²
cable cross section AWG, min.	AWG 22
cable cross section AWG, max.	AWG 6
single conductor, min. H05(07) V-U	0.2 mm ²
single conductor, max. H05(07) V-U	16 mm ²
multi-stranded, min. H07V-R	6 mm ²
multi-stranded, max. H07V-R	16 mm ²
stranded fine wire, min. H05(07) V- K	0.5 mm ²
stranded fine wire, max. H05(07) V- K	16 mm ²
with AEH with collar DIN 46 228/4, min.	0.25 mm ²
with AEH with collar DIN 46 228/4, max.	16 mm ²
with wire end ferrule to DIN 46 228/1, min.	0.25 mm ²
with wire end ferrule to DIN 46 228/1, max.	16 mm ²
Approvals	
Marking	CE in accordance with EMC directive (EN 61000-6-3 & EN 61000-6-2)
Conformity	EN60950 -1 / UL 60950-1 compliant (when installed/in PDB)

Table 17: Technical data of parallel connection of ESX300-S Plus

5.3 Current rating, voltage drop and load capacity of ESX300-S plus

current rating range I_N	typical voltage drop U_{ON} at I_N	active current limitation typically	trip time typically at $1.2 \times I_N$	fail-safe element	max. load current at 100% ON duty $T_{AMB} = 40\text{ }^\circ\text{C}$	max. capacitive load (μF)
32 A* (2 x 16 A)	200 mV	$1.20 \times I_N$	0.2 – 3 s	2 x 20 A	32 A	10000
40 A* (2x 20 A)	160 mV	$1.20 \times I_N$	0.2 – 3 s	2 x 30 A	40 A	12000
44 A* (2 x 24 A)	200 mV	$1.20 \times I_N$	0.2 – 3 s	2 x 30 A	44 A	14000
48 A* (3 x 16 A)	200 mV	$1.20 \times I_N$	0.2 – 3 s	3 x 20 A	48 A	15000
60 A* (3 x 20 A)	160 mV	$1.20 \times I_N$	0.2 – 3 s	3 x 30 A	60 A	18000
60 A* (3 x 24 A)	200 mV	$1.20 \times I_N$	0.2 – 3 s	3 x 30 A	60 A	21000

Table 18: current rating, voltage drop, load capacity

* higher rated current due to parallel connection of several ESX300-S Note. The total current of two neighbouring single devices (also true for parallel connection) must not exceed 44 A. The derating factor at an ambient temperature of > 40 °C is 0.8 times rated current.

5.4 Scope of delivery of ESX300-S Plus connected in parallel

Optional sets are available for the parallel connection of several ESX300-S:

- parallel connection of several ESX300-S Plus (for two ESX300-S) (no.: X22387411)
- parallel connection of several ESX300-S plus (for three ESX300-S) (no.: X22387401)

5.5 Picture of parallel connection of several ESX300-S plus



fig. 23: Front bridge for the parallel connection of two ESX300-S

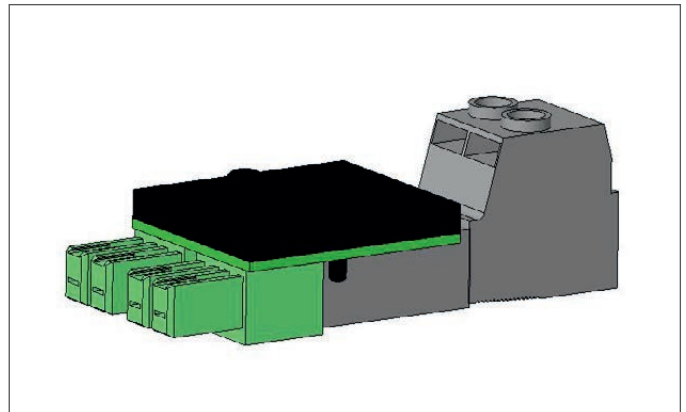

fig. 24: Load bridge for the parallel connection of two ESX300-S

5.6 Installation and start-up of the parallel connection of several ESX300-S Plus



step	action
1	<p>Prepare all necessary devices and tools such as:</p> <ul style="list-style-type: none"> • Electronic circuit protectors ESX300-S (check the ESX300-S with regard to the required current ratings, see chapter 4.5 fig. 16 »rated current«) • For use with PDB- P-CPxxx-xx-Ax (new version of the Power-D-Box® CP), bus-capable circuit protectors such as ESX300-S-3xx are compulsory. • The optional set parallel connection ESX300-S with front bridge and load bridge
2	<p> • ESX300-S connected in parallel always have to be plugged into neighbouring slots. Please observe that only ESX300-S with the same current rating and the same voltage rating must be connected in parallel.</p> <ul style="list-style-type: none"> • ESX300-S that are to be connected in parallel must be switched off before installing the front and load bridges. • The optionally available cable grip rail for the ControlPlex Rack System
3	<ul style="list-style-type: none"> • Use the front bridge to connect the ESX300-S you wish to connect in parallel.
4	<ul style="list-style-type: none"> • Use the load bridge to connect the ESX300-S you already connected in parallel by way of the front bridge.
5	<p> • When using the parallel connection for several ESX300-S, a cable grip rail as a load cables is compulsory.</p>
6	END

Table 19: Installation and start-up of the parallel connection of several ESX300-S plus



fig. 25: Front bridge for the parallel connection of two ESX300-S in plugged-in condition

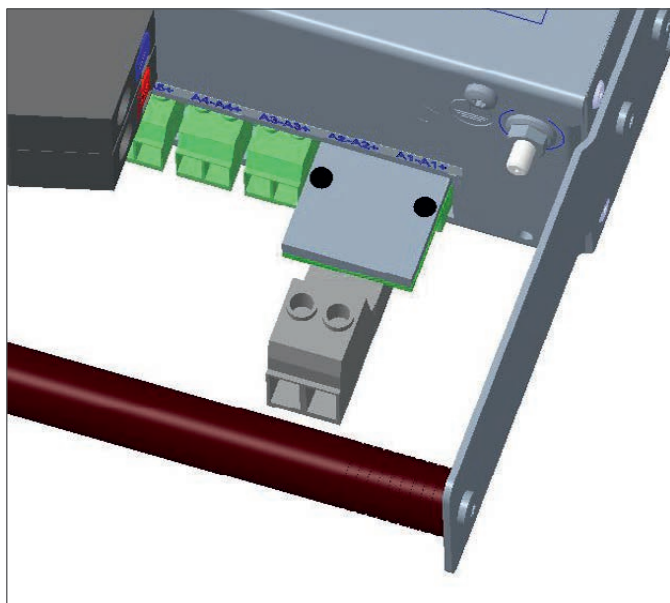

fig. 26: Load bridge for the parallel connection of two ESX300-S in plugged-in condition

6 RSI10 signal interface

The RSI Remote Signalling Interface RSI10 has particularly been designed for use with the **Power-D-Box**[®] CP type PDB- P-CPxxx-xx-x in connection with the circuit protector ESX300-S. It can be installed and de-installed with the system live without having to disconnect the application from the mains. Thus you are able to add the RSI10 interface sub-assembly later if required, saving costs and avoiding downtimes.

6.1 Application RSI10

The Remote Signalling Interface RSI10 is designed for an operating voltage of DC 20 V to DC 75 V. It communicates with all other ESX300-S circuit protectors installed in the **Power-D-Box**[®] via an internal bus. Thus it is possible to realise a potential-free group signalling of alarm messages of the ESX300-S electronic circuit protectors used in the system (version with bus interface. Per supply group of the **Power-D-Box**[®] CP, the RSI10 provides one each potential-free change-over contact. An integral three-coloured LED additionally indicates failure conditions directly on site. The system can easily be extended at a later date to add the functions remote control, data logging and extended alarm monitoring by means of replacing the RC110 sub-assembly by RSI10 without a failure of the connected loads.

6.2 Technical data of RSI10

Technical data ($T_{amb} = 25\text{ °C}$, $U_B = \text{DC } 48\text{ V}$)	
Rated voltage U_B	DC 20 V ... DC 75 V (Power-D-Box [®] CP input voltage)
Dielectric strength	DC 100 V for 1 ms
Power consumption I_o	typically 25 mA at 48 V Operating voltage
power consumption	typically 1.2 W
Interfaces and protocols	
Internal interface	Internal interface ELBUS/ power, 20-pole pcb connector
External connection	two plug-in type 3-pole screw terminals with mating connector
Auxiliary circuit (alarm contacts)	
Contact	potential-free change-over contact
Max. switching voltage	DC 72 V
Rupture capacity	60 W / 62.5 VA
Technical data:	
Design	rack without enclosure
Degree of protection	operating area IP20 (when rack is fully populated and SUB-D connectors are plugged in) Terminal area IP00 DIN 40050
Mass	typically 60 g
Mounting position	vertical, cooling by means of convection
Status indication / momentary switch (function see table 3)	
Status LED	multicoloured (red, green, blue)
General data	
Leakage current in OFF condition	typically 1 mA
Back-up fuse	not required due to integral fail-safe element

Environmental conditions	
Operating temperature	-20 ... +60 °C (without condensation, cf. EN 60204-1)
Ambient temperature	-20 °C ... +60 °C without condensation see EN50240-1
Storage temperature	-20 °C ... +70 °C
Humidity	96 hours at 95% RH, 40 °C, to IEC 60068-2-78, climate class 3K3 to EN60721
Marking and approvals	
ESD	4 kV/air 8 kV
EMC requirements	to EN 61000-6-3 & EN 61000-6-2
Vibration resistance	3 g to IEC 60068-2-6,
Marking	CE in accordance with EMC directive (EN 61000-6-3 & EN 61000-3-2)
Conformity	EN 60950-1/UL 60950-1 compliant (when installed/in PDB)

Table 20: RSI10, technical data

6.2.1 Operating conditions and switching status including LED indication

operating condition of circuit protector ESX300-S-3xx	load output ESX60D ESX300-S-3xx	LED status RSI10 sub-assembly	auxiliary contact RSI10 sub-assembly group signal »break contact«	operating status RSI10 sub-assembly
no error -> OFF	locked	green	open	normal operation
normal operation	connected	green	open	normal operation
error undervoltage with device in OFF condition (15 V < U < 37 V)	locked	green	closed	normal operation
error undervoltage with device in OFF condition (U > 72 V)	locked	green	closed	normal operation
error overcurrent detected ($I > I_N < 1,2 \times I_N$) overcurrent failure has to be detected for approx. 30 sec before disconnection is effected	connected	green	open	normal operation
error overcurrent or short circuit disconnection	locked	green	closed	normal operation
error undervoltage (15 V < U < 37 V)	connected	green	closed	normal operation

error overvoltage (72 V < U < 75 V)	connected	green	closed	normal operation
error: no voltage	locked	OFF (green) ¹	closed	normal operation ¹
	locked	green	closed	normal operation
		green	closed	no ESX300-S circuit protector available. check if ESX300-S bus version is plugged in
-----	-----	red	closed	internal RSI10 error or internal bus error
-----	-----	5 sec blue	open	one new circuit protector ESX300-S was identified

Table 21: RSI10, operating conditions – LED

¹ In a redundant system with two supply voltages, the green LED lights if only one voltage supply fails, otherwise the RSI10 sub-assembly is deadvoltage.

6.3 Delivery scope RSI10

The following parts are part of the delivery scope of the RSI10:
Remote Signalling Interface: RSI10-xxx-A with front plate and label including alarm connection mating plug

6.4 Picture of RSI10

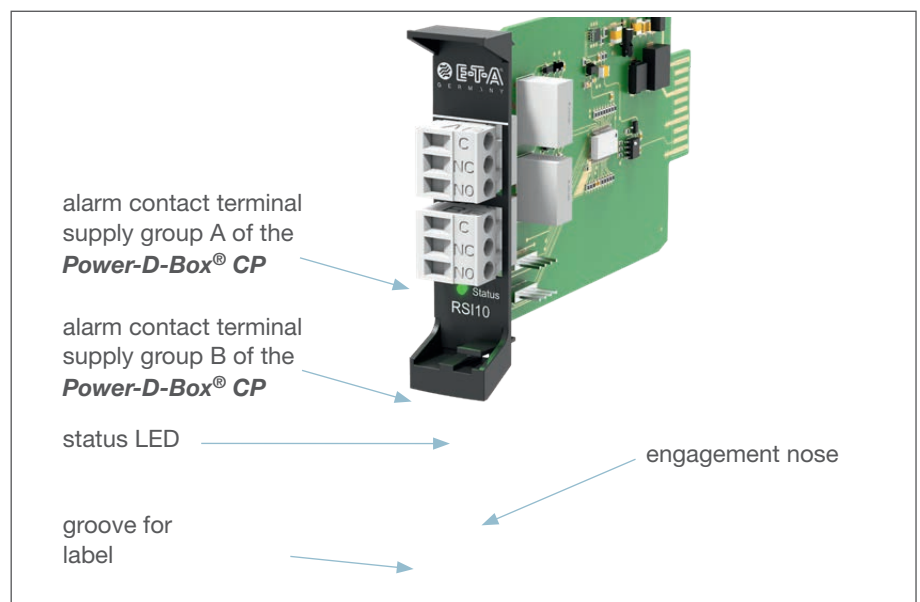

fig. 27: RSI10 sub-assembly

Start-up of the RSI10 sub-assembly comprises the following steps:

step	action
1	Prepare all necessary devices and tools such as: <ul style="list-style-type: none"> • RSI10 remote control interface • connecting cables for an external alarm signalling
2	 Important: Please make sure that all steps in chapter 3 »Start-up of the <i>Power-D-Box</i>[®] CP« and in chapter 4 »Start-up of ESX300-S« are carried out correctly.
4	Installation of the RSI10 sub-assembly into the <i>Power-D-Box</i>[®] CP: Push the RSI10 sub-assembly carefully into slot X0 and push until latch-on in the front plate in the <i>Power-D-Box</i> [®] , see fig. 22.
5	Check the LED indication of the RSI10: The green status LED must be lighted continuously latest after 10 seconds. If this is not the case, please go chapter 5.2.1 LED operating conditions and remedy the failure. Do not continue with step 6 before the green LED is lighted continuously.
6	Connection of an external alarm display Connect a prepared external alarm indication via the 3-pole alarm contact terminal to the plug of the corresponding screw terminal (C = root; NC = break contact; NO = make contact). An error signal can be indicated via C / NC, an OK signal via C/NO. Group signalisation of the <i>Power-D-Box</i> [®] CP for supply group A = upper 3-pole terminal on RSI10 Group signalisation of the <i>Power-D-Box</i> [®] CP for supply group B = lower 3-pole terminal on RSI10 Note: If there is only one supply group on the <i>Power-D-Box</i> [®] , the group alarm signal »A« is emitted at both terminal blocks.
7	Extension with additional circuit protectors The RSI10 LED must be lighted in blue for approx. 5 sec. This means that the newly plugged in circuit protector was identified, see also chapter 5.2.1.
	END

Table 22: RSI10, installation and connection

5.5 Installation and start-up RSI10

Important notes



	Information: <i>Power-D-Box</i>[®] CP and ESX300-S installed Before starting the installation, the <i>Power-D-Box</i> [®] has to be properly installed first and supply voltage should be applied. All steps in chapter 3.8.3 and chapter 4.5 were carried out properly.
	Caution: work with ESD protection To protect electronic components against electrostatic voltage, any work must only be carried out with corresponding ESD protection means. Failure to comply can cause damages on the <i>ControlPlex</i> [®] Rack system or the corresponding components.
	Important: Mounting position The RSI10 sub-assembly has to be pushed in vertically into the <i>Power-D-Box</i> [®] CP in slot: X0.

Table 23: RSI10, Important hints for start-up

7 General: ControlPlex® Rack, control interface RCI10

The RCI10 Remote Control Interface has particularly been designed for use with the **Power-D-Box® CP** type PDB- P-CPxxx-xx-x in connection with the circuit protector ESX300-S. It can be installed and de-installed with the system live without having to disconnect the application from the mains. Thus you are able to add the interface sub-assembly later if required, saving costs and avoiding downtimes.

7.1 Application RCI10

The RCI10 Remote Control Interface is designed for an operating voltage of DC 20 V to DC 75 V. It communicates with all circuit protectors type ESX300-S-3xx-xxA (version with BUS interface) CP installed in the **Power-D-Box®** via an internal BUS. The RCI10 can easily be interconnected with a local LAN network via an external Ethernet interface. Various integral protocols allow a complete automation and remote control of the individual circuit protectors, e.g. ON/OFF operation depending on the voltage or current value. In addition alarm signals and a continuous data recording per query can be forwarded to a connected control computer.

7.2 Technical data of RCI10

Interface card for measuring data recording, automation and remote control of all circuit protectors installed in the **ControlPlex® Rack**.

5.2 Technical data of RCI10	
Operating voltage	DC 20 V ... DC 75 V
Dielectric strength	DC 100 V for 1 ms
Power consumption	typical 2 – 3 W
Internal connection	20-pole pcb connector (EL-BUS, power etc.)
External connection	Ethernet 10 / 100 Base-T, RJ45-connection sleeve for standard network cable of category Cat-5, type »Shielded Twisted Pair«
Status indication	RGB LED (red, green, blue)
Momentary switch	reset and special functions
Supported protocols	SNMP v1, v2c, v3; HTTP, HTTPS, SSH2, DHCP, NTP, IPv4, IPv6
Operating temperature	- 20 °C ... + 60 °C (without condensation, cf. EN 60204-1)
Storage temperature	-30 °C ... +70 °C
Cooling	convection cooling
Mounting position	vertical mounting position
Version	rack module with front plate, no separate enclosure, for installation in Power-D-Boxes® CP
Degree of protection	IP00 DIN 40050
Approval logos	CE to EN 61000-6-3 / EN 61000-6-2
Conformity	EN 60950-1 / UL 60950-1 compliant (when installed in PDB)

Table 24: RCI10, technical data

7.2.1 LED operating conditions, momentary switch »Reset« and failure remedy

»Reset« momentary switch	LED colour	LED condition:	meaning	description / action
–	green	ON	normal operation	The green LED is lighted continuously when booting is completed and the RCI10 is operating faultlessly. Network connection can be established after another 10 sec.
pushed down for 35 sec	green	blinking	reset IP address to factory settings	By pushing the »Reset« button for 35 seconds, the IP settings can be reset. For visual control that the reset button has been pushed down long enough, the green LED will blink for 5 seconds. Release the momentary switch while the LED blinks, see fig. 19
–	red	ON	internal failure RCI10	The red LED indicates a serious internal failure in the RCI10 sub-assembly. The sub-assembly is no longer operational. By means of a cold boot (remove the sub-assembly – wait for 20 seconds - plug in again) the failure may be remedied. The RCI10 sub-assembly should be replaced nevertheless.
–	red	ON	serious internal failure BUS (EL-BUS)	The red LED indicates an EL-BUS failure. The communication with the circuit protector ESX300-S and the RCI10 is disrupted. This problem can be caused by a defective circuit protector or a defective RCI10 sub-assembly.
–	blue	ON	Ethernet link available	If a network connection is established in operation (layer 1), the LED will be lighted blue for some 10 seconds.
–	blue	ON	reset IP address to factory settings	The blue LED will be lighted for 10 seconds when the IP address has successfully been reset to factory settings, see fig. 19. Automatic booting will follow, this can last up to 60 seconds.
–	–	OFF	booting	The RCI10 sub-assembly is booting. Booting can take up to 60 seconds.
–	–	OFF	no supply voltage	No supply voltage or wrong polarity. ¹⁾ The voltage supply of the Power-D-Box [®] must at least be DC 20 V. ²⁾ Check polarity of the power supply at the Power-D-Box [®] if correct (plus/ minus).
pushed down for 3 sec	–	OFF	warm boot	The system can be reset by pushing the »Reset« button for 3 seconds (warm boot)
	–	OFF	RCI10 sub-assembly defective	If the LED remains unlighted after booting (max. 60 sec), the RCI10 sub-assembly is defective. The sub-assembly must be replaced.

Table 25: RCI10, operating conditions – LED

7.2.2 Function IP-reset by pressing the reset button with LED display

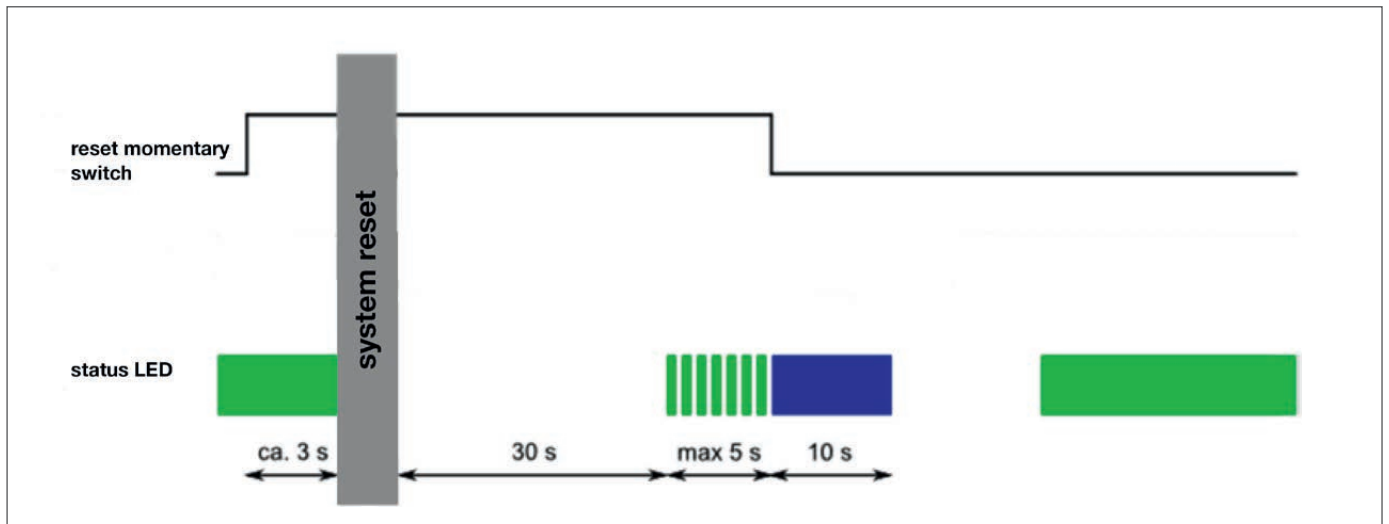

fig. 28: RCI10 IP-Reset

7.3 Delivery scope RCI10

The following parts are part of the delivery scope of the RCI10:

- Remote control interface, type: RCI10-xxx-A with front plate

7.4 Picture of RCI10

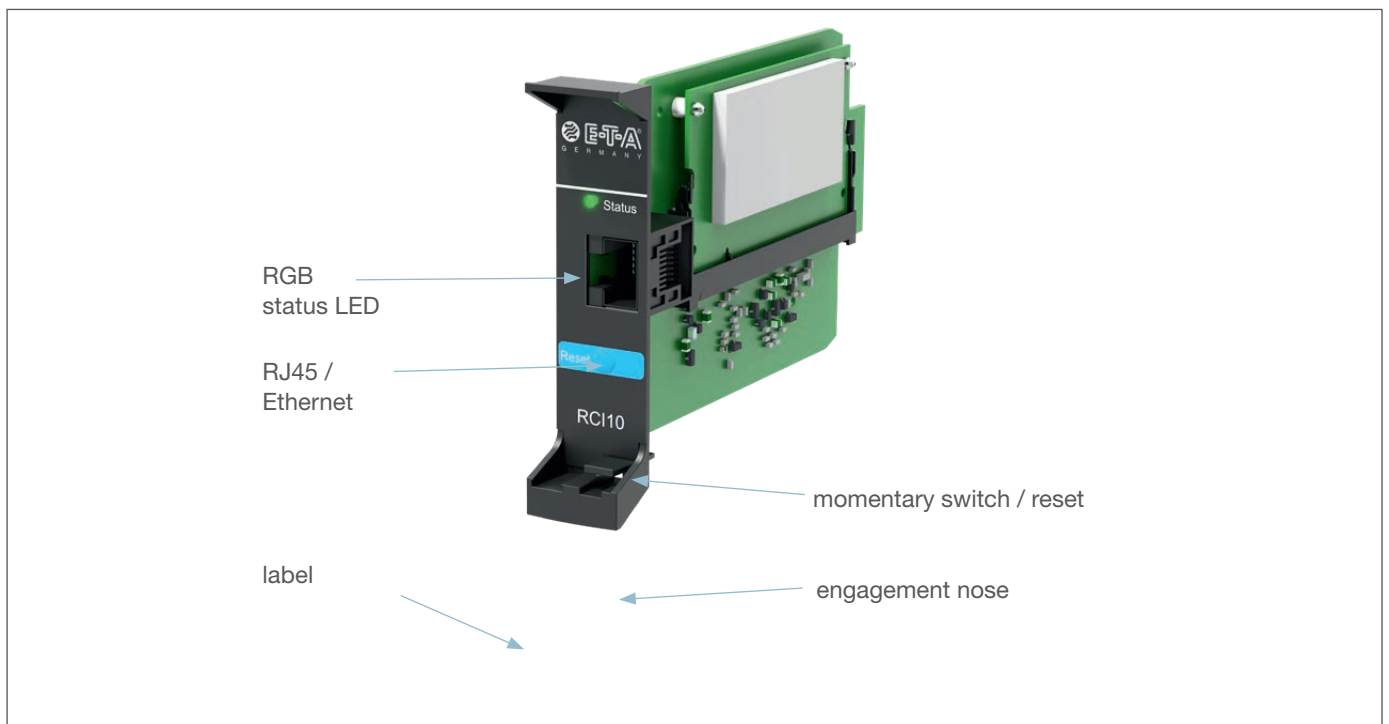

fig. 29: RCI10 sub-assembly

7.5 Installation and start-up RCI10

Important notes



	<p>Note: <i>Power-D-Box</i>[®] CP and ESX300-S and/or EAI300 installed Before starting the installation, the <i>Power-D-Box</i>[®] has to be properly installed first and supply voltage should be applied. All steps in chapter 3.9.3, chapter 4.5 and (optional) chapter 8.5 were carried out properly.</p>
	<p>Caution: Work with ESD protection To protect electronic components against electrostatic voltage, any work must only be carried out with corresponding ESD protection means. Failure to comply can cause damages on the <i>ControlPlex</i>[®] Rack system or the corresponding components.</p>
	<p>Warning: Mounting position The RCI10 sub-assembly has to be pushed in vertically into the <i>Power-D-Box</i>[®] in slot: X0.</p>

Table 26: RCI10, Important hints for start-up

Installation and connection of the RCI10 sub-assembly comprise the following work steps:



step	action
1	Prepare all necessary devices and tools such as: <ul style="list-style-type: none"> • Remote Control Interface RCI10 • Ethernet cable 10 / 100 Base-T with the correct terminal length
2	 <p>Important: Please make sure that all steps in chapter 3 »Start-up of the <i>Power-D-Box</i>[®] CP« and in chapter 4 »Start-up of ESX300-S« are carried out correctly.</p>
3	 <p>Important: Please make sure that any connected signalling cables (group signalling) on the <i>Power-D-Box</i>[®] are de-installed. Should voltage be applied here, parts of the <i>ControlPlex</i>[®] Rack could be destroyed.</p>
4	<p>Installation of the RCI10 sub-assembly into the <i>Power-D-Box</i>[®] CP: Push the RCI10 sub-assembly carefully into slot X0 and push until latch-on in the front plate in the <i>Power-D-Box</i>[®], see fig. 29.</p>
5	<p>Check the LED indication of the RCI10: The green status LED must be lighted continuously latest after 60 seconds. If this is not the case, please go chapter 7.2.1 LED operating conditions and remedy the failure. Do not continue with step 6 before the green LED is lighted continuously.</p>
6	<p>Connection of the Ethernet cable Plug the Ethernet cable into the RJ45 connector of the RCI10 sub-assembly, see fig. 28, and connect it to your internal network or directly with a configuration PC, see fig. 30.</p>
7	 <p>Go to chapter 7.6 and configure the RCI10 sub-assembly according to your requirements.</p>
	<p>END</p>

Table 27: RCI10, installation and connection

7.5.1 Picture of slot for RCI10 or RSI10

Information: The slot X0 is at the same position with all PDB- P-CPxxx-xx-x versions, first slot on the left side.



fig. 30: PDB slot X0

7.5.2 Picture of an example for network connection

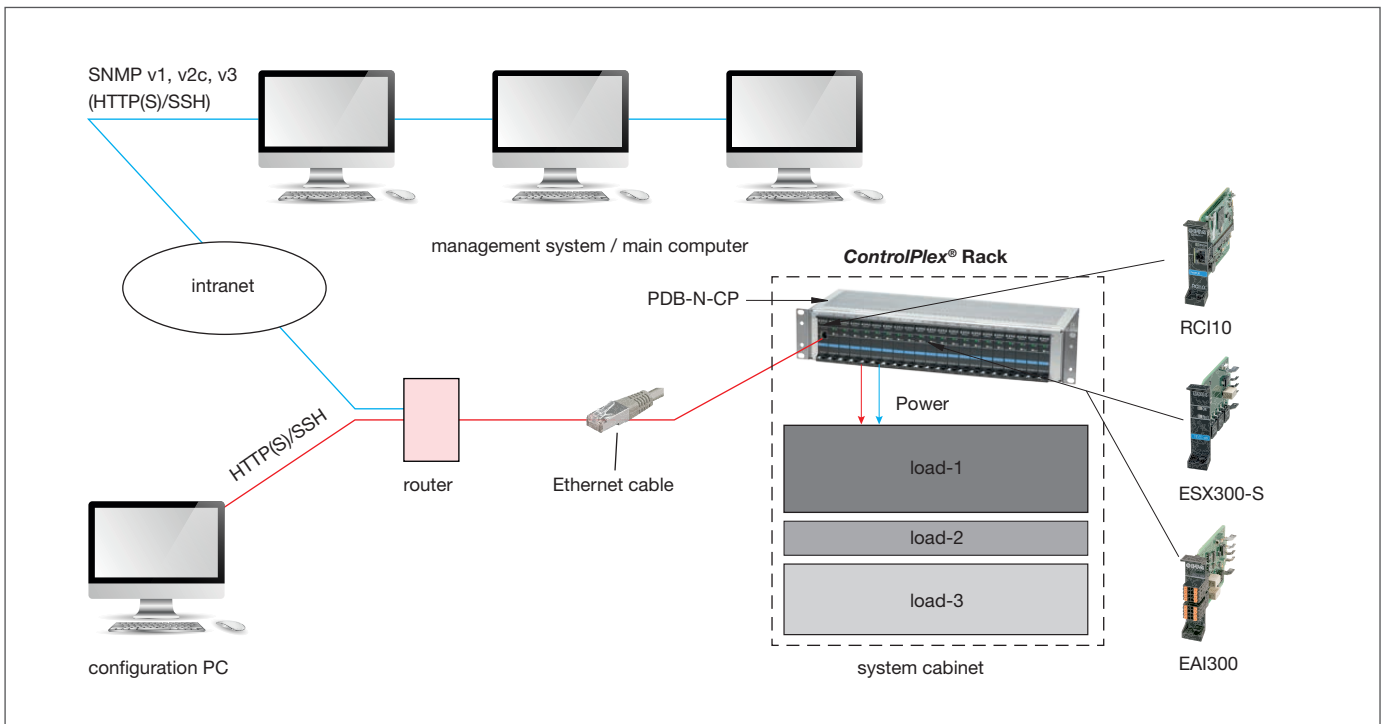

fig. 31: Connection example network

7.6 Configuration and start-up RCI10

For configuring the RCI10 sub-assembly you need the **ControlPlex® Rack** Instruction manual RCI10.

In order to establish a logic connection in your LAN network with a configuration PC, the RCI10 sub-assembly has to be connected with the PC via an Ethernet cable, see fig. 30.

The document **ControlPlex® Rack** Instruction manual RCI10 is available on our homepage: www.e-t-a.de/controlplex Rack

8 General: *ControlPlex*[®] Rack, EAI300 E/A external alarm interface

The EAI300 has particularly been designed for use with the *Power-D-Box*[®] type PDB-N-CP in connection with the remote control interface RCI10. It can be CP installed and de-installed in the *Power-D-Box*[®] CP later with the system live without having to disconnect the application from the mains. The EAI300 only requires a free ESX300 slot (slot for circuit protectors) in the *Power-D-Box*[®] CP.

8.1 Operating mode and application EAI300

The EAI300 has been conceived for connection and free text indication of alarm messages from »external« alarm contacts and sensors in the plant room by means of a control computer. This could include door contacts, temperature sensors or alarm contacts of the air conditioning system. The EAI300 interface communicates with the RCI10 Remote Control Interface CP installed in the *Power-D-Box*[®] CP via an internal bus. The RCI10 sub-assembly communicates with a management system or a control computer by means of an Ethernet interface. With the help of an integral LED an »externa« alarm can also be indicated locally on the EAI300. An integral 24 V voltage output can be used directly for reading the alarm contacts. Equally, there are two potential-free outputs available for activating e.g. a door lock or for realising an additional group signalling of the ESX300 circuit protectors. Within a *Power-D-Box*[®] CP you can install up to 20 EAI300 sub-assemblies.

8.2 Technical data of EAI300

Interface card for forwarding additional alarms in the engineering room, so-called »external alarms«.

Technical data of EAI300	
Operating voltage	DC 20 V ... DC 75 V
Dielectric strength	DC 100 V for 1 ms
power consumption	typical 1.9 W
Internal interface	EL-Bus [®] and supply via blade terminals
External connection	Two plug-in type 8-pole connection sleeves with spring-loaded connectors on the front side Cross-section 0.14 mm ² ... 1.5 mm ²
Number of digital inputs:	Eight physically isolated inputs
Current consumption	1 mA at 24 V
Input resistance:	22.1 kOhm
Voltage potential »HIGH« level	DC 12 V ... DC 72 V
Voltage potential »LOW« level	DC 0 V ... DC 4 V
Number of analog inputs:	one physically isolated input
Measuring input	4 mA ... 20 mA
Number of digital outputs (relay outputs)	Two physically isolated relay outputs (break contacts)
Max. load current of contact	2 A
Voltage range – contact	DC 12 V ... DC 72 V
Internal supply voltage for I/O connection	typically DC 24 V (at <i>Power-D-Box</i> [®] supply voltage ≥ DC 30 V)
Max. load current:	100 mA

External supply voltage for I/O connection	DC 12 V ... DC 72 V
Max. number of EAI300 sub-assemblies per <i>Power-D-Box</i> ® CP and RCI10 sub-assembly	20 (<i>Power-D-Box</i> ® CP depending on type)

Table 28: EAI300, technical data

*) major technical data, for further information please see data sheet of ControlPlex® Rack

8.2.1 Operating conditions LED signalling

Operating condition EAI300	LED indication EAI300
EAI300 normal duty	green
EAI300 normal duty: digital input has status »High«	green / cyan blue blinking
EAI300 normal duty: identified new circuit protector ESX300 (relay output configured as group signal)	5 seconds blue
EAI300 fault condition: Control interface RCI-10 not available	red blinking
EAI300 fault condition: EAI300 internal fault	red
EAI300 fault condition: RCI10 not available and digital input has status »High«	red / cyan blue blinking

Table 29: EAI300, operating conditions – LED

8.3 Delivery scope EAI300

The following parts are standard part of the delivery scope of the EAI300:

- External Alarm Interface, type: EAI300-xxx-A with front plate including spring force mating plugs
- Accessories: 16 labels and coding pin for spring force mating plugs

8.4 Picture EAI300



fig. 32: External Alarm Interface EAI300

8.5 Installation and connection EAI300

Important notes





	<p>Note: <i>Power-D-Box</i>[®] and additional sub-assemblies installed</p> <p>Before starting the installation, the <i>Power-D-Box</i>[®] has to be properly installed first and supply voltage should be applied. All steps in chapter 3 were carried out properly.</p>
	<p>Caution: Work with ESD protection</p> <p>To protect electronic components against electrostatic voltage, any work must only out with corresponding ESD protection means. Failure to comply can cause damages on the <i>ControlPlex</i>[®] <i>Rack</i> system or the corresponding components.</p>
	<p>Warning: Mounting position</p> <p>The EAI300 sub-assembly has to be pushed in vertically into the <i>Power-D-Box</i>[®].</p>

Table 30: EAI300, Important hints for start-up

Installation and connection of the EAI300 sub-assembly comprise the following steps:

step	action
1	<p>Prepare all necessary devices and tools such as:</p> <ul style="list-style-type: none"> • External Alarm Interface EAI300 and accessories • connecting cables for external Alarm Interface • Probably a distribution terminal is required
2	<p style="text-align: center;"></p> <p>Important: Please make sure that all steps in chapter 3 »Start-up of the <i>Power-D-Box</i>[®] CP« and in chapter 4 »Start-up of ESX300-S« are carried out correctly.</p>
3	<p style="text-align: center;"></p> <p>Important: INSTALLATION POSITION</p> <p>When using the EAI300 together with ESX300-S circuit protectors within one <i>Power-D-Box</i>[®] CP, the EAI300[®] should always be plugged into the highest slot of the <i>Power-D-Box</i>[®] CP, e.g. with <i>Power-D-Box</i>[®] CP model PDB- P-CP19A... into slot 19, the following EAI300 into slot 18 etc.</p>
4	<p>Installation of the EAI300 sub-assembly into the <i>Power-D-Box</i>[®] CP:</p> <p>Push the EAI300 sub-assembly carefully into the corresponding slot and push until latch-on in the front plate in the <i>Power-D-Box</i>[®] CP, see chapter 8.5.1 »example EAI300 slot configuration«</p>
5	<p>Check the LED indication of the EAI300:</p> <ol style="list-style-type: none"> 1. RCI10 sub-assembly already pre-installed: The green status LED must be lighted continuously. 2. RCI10 sub-assembly not installed: The red status LED must be blinking. <p>If this is not the case, please go chapter 8.2.1 LED operating conditions and remedy the failure. Do not continue with the next step before the LED status indication shows the correct condition.</p>
6	<p>Plug coding and plug numbering</p> <p>Please code the plug X5 and number the contacts of the plugs X5 and X6 with the supplied accessory set, see chapter 8.5.2 »EAI300 pin assignment and connection example«</p>
7	<p>Connection of »external« alarm contacts</p> <p>Connect the »external« alarm contacts / alarm outputs with the appropriate terminals of the EAI300 via the connectors, please see chapter 8.5 2 »EAI300 connection example«</p>



8	<p>Please record each connected alarm contact</p> <p>You will require this information later for the logical assignment of the alarms (software configuration)</p> <p>Example: »Door contact cabinet 1 = PDBxx- slot A19/digital input 1«</p>
9	<p>Repeat step 1 - 8 for each EAI300 to be installed.</p>
10	<p> No RCI10 sub-assembly pre-installed</p> <p>Go to chapter 6 and install the RCI10 sub-assembly</p>
11	<p> RCI10 sub-assembly pre-installed</p> <p>Go to chapter 7.6 and configure the EAI300 sub-assembly according to your requirements.</p>
<p>END</p>	

Table 31: EAI300, installation and connection

8.5.1 Example: EAI300 slot configuration (mixed population with ESX300 and EAI300)

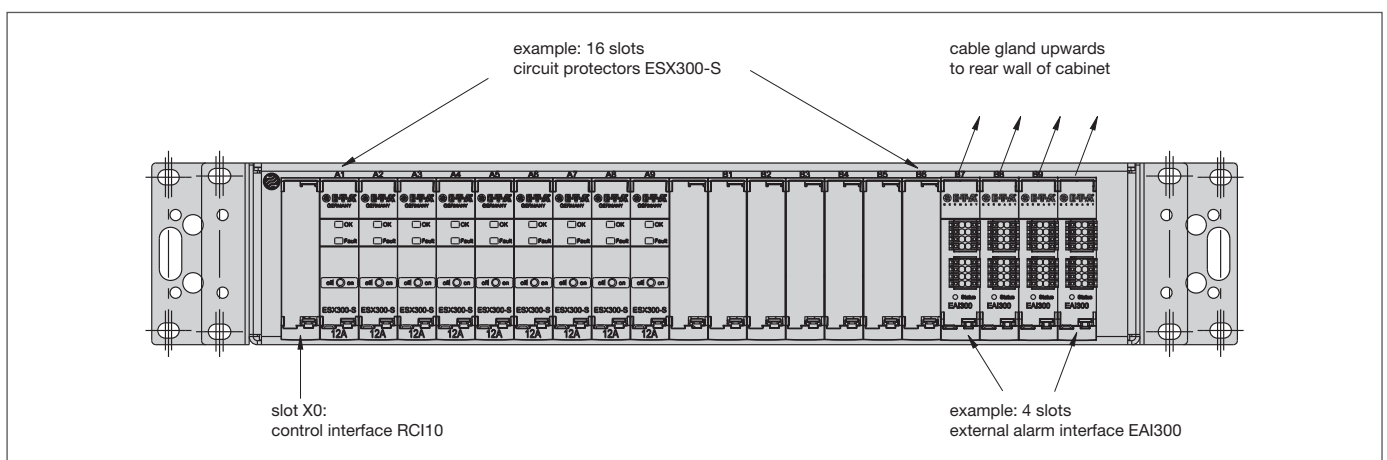

fig. 33: EAI300 slot configuration

8.5.2 EAI300 pin assignment and connection example

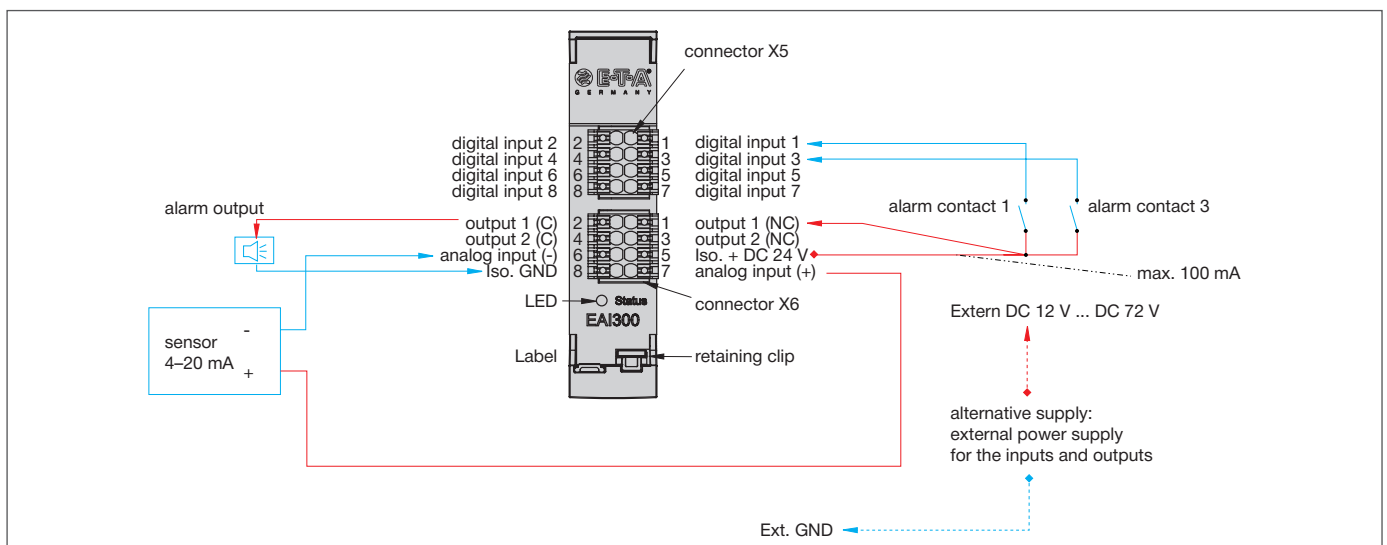

fig. 34: EAI300 pin assignment and connection example

8.6 Configuration and start-up EAI300

For configuring the EAI300 sub-assembly you need the **ControlPlex® Rack** Instruction manual RCI10. The document »Instruction Manual Remote Control Interface RCI10« is available on our website: www.e-t-a.de/controlplex_rack.

9 Appendix

9.1 List of pictures

fig. 1:	front view PDB-P-CP18R-RR-A, PDB-P-CP19A-RR-Ax	11
fig. 2:	front view PDB- P-CP09A-RR-Ax	11
fig. 3:	front view PDB- P-CP09A-FF-Ax terminals on the front with high current SUB-D connectors	11
fig. 4:	front view PDB-P-CP09A-FF-Ax, 1 x 9 slots, terminals on the front with high current SUB-D connectors	12
fig. 5:	rear view PDB- P-CP09A-FF-Ax 1 x 9 slots (with rear cable grip rail)	12
fig. 6:	front view PDB-P-CP19A-RR-Ax, 1 x 19 slots	12
fig. 7:	rear view DB- P-CP19A-RR-Ax without cable grip	12
fig. 8:	front view PDB- P-CP18R-RR-Ax 2 x 9 slots	13
fig. 9:	front view PDB- P-CP18R-RR-Ax 2 x 9 slots	13
fig. 10:	top view PDB- P-CP18R-RR-Ax 2 x 9 slots (with rear cable grip rail)	13
fig. 11:	sSchematic diagram PDB- P-CP19A-RR-Ax, 1 x 19 slots with signalling	14
fig. 12:	schematic diagram PDB- P-CP18R-RR-Ax, 2 x 9 slots with signalling	14
fig. 13:	version PDB- P-CP18R-RR-A, pin assignment (cable grip removed/ Minus version)	14
fig. 14:	version PDB- P-CP09A-FF-Ax, pin assignment	15
fig. 15:	version PDB- P-CP19A-RR-Ax, pin assignment (cable grip installed)	15
fig. 16	ESX300-S plus circuit protector	21
fig. 17:	ESX300-S plus with slide switch to adjust voltage rating	22
fig. 18:	ESX300-S interlock	24
fig. 19:	ESX300-S removal	24
fig. 20:	extracting tool for ESS300-S	25
fig. 21:	extracting tool for ESS300-S	25
fig. 22:	extracting tool for ESS300-S	25
fig. 23:	front bridge for the parallel connection of two ESX300-S	28
fig. 24:	load bridge for the parallel connection of two ESX300-S	28
fig. 25:	front bridge for the parallel connection of two ESX300-S in plugged in condition	29
fig. 26:	load bridge for the parallel connection of two ESX300-S in plugged-in condition	29
fig. 27:	RSI10 sub-assembly	32
fig. 28:	RCI10 IP-Reset	36
fig. 29:	RCI10 sub-assembly	36
fig. 30:	PDB slot X0	38
fig. 31:	connection example network	38
fig. 32:	External Alarm Interface EAI300	40
fig. 33:	EAI300 slot configuration	42
fig. 34:	EAI300 pin assignment and connection example	42



E-T-A Elektrotechnische Apparate GmbH
Industriestraße 2-8 . 90518 ALTDORF
GERMANY
Tel. 09187 10-0 . Fax 09187 10-397
E-Mail: info@e-t-a.de . www.e-t-a.de